



*Ease your life*

2025



*Ease your life*



Torbali / IZMİR / TÜRKİYE   
Manufacturing Facility



 Yazibasi / IZMİR / TÜRKİYE  
Manufacturing Facility

# EGE, Makes *Life* Easier

Established in 1996, Ege Home Products Inc. started its commercial activities with the production of ironing boards, clothes dryers and step ladders. Manufacturing in its two factories in Izmir Torbali with over 500 employees in a closed area of 90,000 m<sup>2</sup>, it has reached a leading position in its sector by adding camping products to its product range over the years.

Adopting excellence as a principle in all its processes with its consumer-oriented approach and new models it has developed, Ege Home Products Inc. delivers its products and services to clients in more than 120 countries on 6 continents.

Thanks to the energy produced by the solar panels installed on an area of 55,000 m<sup>2</sup>, it fulfills its responsibility towards the environment and reinforces the main principle of sustainability.

From tube production to paint shop, from plastic injection line to assembly, from fabric workshop to storage Ege Home Products Inc. carries out all production stages in its modern integrated facilities and manufactures its products of high standards by keeping the quality of the materials used under strict control.

**29**  
Years Of  
Experience

**120**  
Export  
Countries

**90.000**  
m<sup>2</sup> Production  
Area

**30.000**  
m<sup>2</sup> Warehouse  
Space

**96.000**  
Tons of Tubes  
Per Year

**16M**  
Finished Products  
Per Year

**%100**  
Solar Energy  
Production

**500+**  
Happy  
Workers



# Index

## **IRONING BOARDS** ..... 6-34

18327 MONO MONDO .....	8	18355 DINAMIC .....	21
18326 MONDO .....	9	18368 SERA .....	22
18324 JUMBO .....	10	18346 BONUS .....	23
18323 VIVA .....	11	18356 IDEAL .....	24
18320 PRESTIGE .....	12	18349 AQUA 25 .....	25
18315 FOCUS .....	13	18364 AQUA 21 .....	26
18318 DREAM .....	14	18366 DIAMOND .....	27
18304 CAPITOL .....	15	18347 POWER .....	28
18301 CARINO .....	16	18343 BASIC .....	29
18325 MAGIC .....	17	18344 BRAVA .....	30
18340 ATOS .....	18	18358 ONE .....	31
18367 ARES .....	19	18359 MINI ONE .....	32
18369 ADA .....	20	18360 TABLE TOP .....	33
		DETAILS .....	34

## **CLOTHES DRYERS** ..... 40-69

18139 STREAM / 4 .....	42	18133 FLEXY 220 .....	55
18138 STREAM / 3 .....	43	18132 FLEXY 160 .....	56
18137 STREAM / 2 .....	44	18130 COSMOS .....	57
18142 ISTANBUL LUX .....	45	18128 SMART .....	58
18111 WINGS LUX .....	46	18117 FLORA .....	59
18111-01 HERO .....	47	18116 HANDY .....	60
18109 WINGS BODRUM .....	48	18105 CAPRI LUX .....	61
18124-01 FANTASY LUX .....	49	18101 CAPRI .....	62
18124 FANTASY .....	50	18114 JUNIOR .....	63
18120-01 AEGEANSTAR LUX .....	51	18161 SMYRNA .....	64
18120 AEGEANSTAR .....	52	18108 THINK .....	65
18121 STAR .....	53	18143 LUNA .....	66
18110 UNO .....	54	DETAILS .....	67

***CAMPING PRODUCTS*** ..... **72-89**

18610 PALIO .....	72
18632 NARIO .....	73
18618 DANTE .....	74
18636 LUCCO .....	75
18626 PAPSY .....	76
18638 TITO .....	77
18674 COMFY .....	78
18645 PICCO .....	79
18658 RETRO .....	80
18672 PIXY .....	81
18670 PRETTY .....	82
18664 TINO .....	83
18660 GIAN .....	84
18668 FISHER .....	85
18690 MATTY .....	86
18695 POPPY .....	87
18680 SUNSHINE .....	88
DETAILS .....	89

***TINY HOUSES*** ..... **90-97**

6500 FLAT (2+0) .....	92
6500 FLAT (1+1) .....	94
8500 FLAT (2+1) .....	96

*Pruning*



Boards

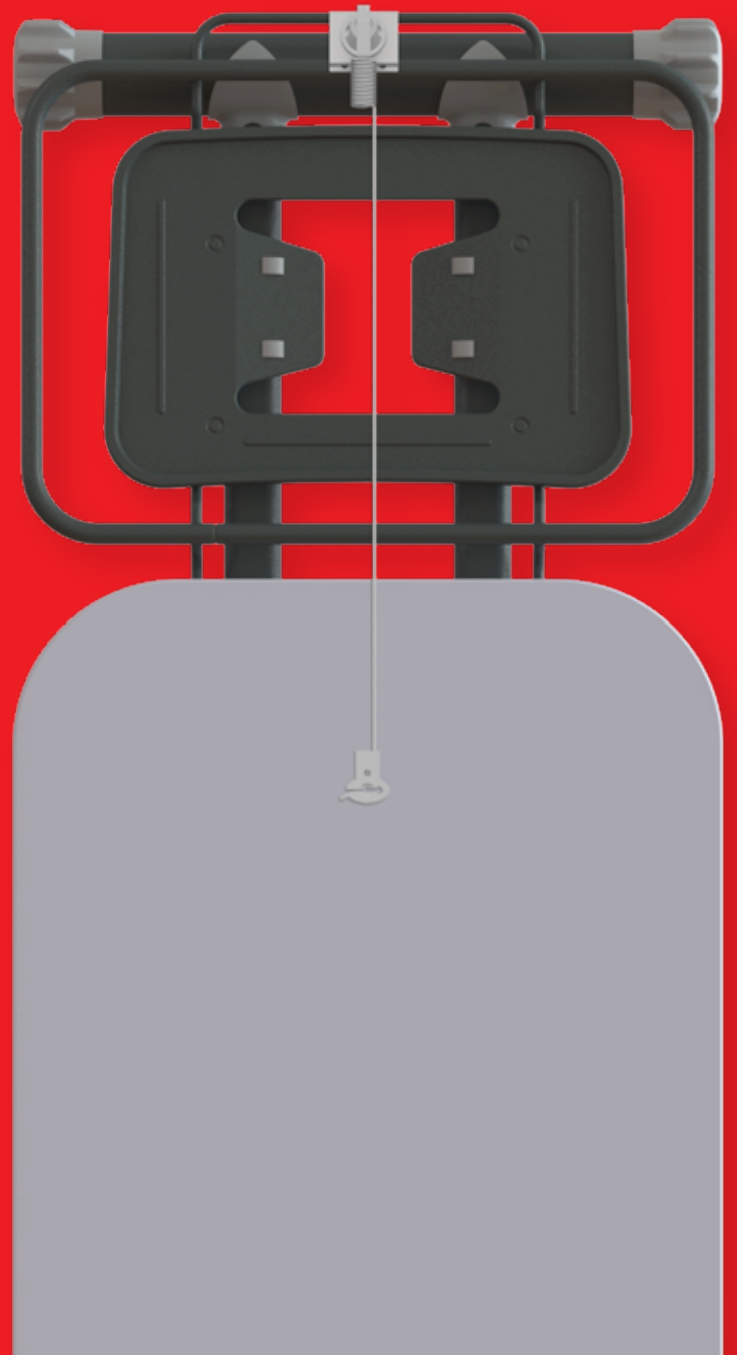



# MONO MONDO

18327

*Ironing*



### Metal Colours



Details

Item	Material	Surface Type	Weight Item / Master	Item Open Size a x b x c (cm)	Ironing Surface Size (cm)	Item Closed Size (cm)	m <sup>3</sup> Item / Master	Tube Size (a)	Master Size a x b x c (cm)	Pcs. per Master	EAN
Mono Mondo 18327	100% Steel With Epoxy Powder Coating	Monoblock	8,75 / 18,3	156x98x43	43x125	43x168	0,056 / 0,113	20x35-51	15x170x44,5	2	8697435183273

# MONDO

18326

*Board*



Metal Colours



Details

Item	Material	Surface Type	Weight Item / Master	Item Open Size a x b x c (cm)	Ironing Surface Size (cm)	Item Closed Size (cm)	m <sup>2</sup> Item / Master	Tube Size (e)	Master Size a x b x c (cm)	Pcs. per Master	EAN EAN
Mondo 18326	100% Steel with Epoxy Powder Coating	Mesh	8,11 / 16,5	156x98x43	42x125	43x168	0,056 / 0,113	20x35-51	15x170x44,5	2	8697435183266

# JUMBO

18324

*Ironing*



### Metal Colours



Item	Material	Surface Type	Weight Item / Master	Item Open Size a x b x c (cm)	Ironing Surface Size (cm)	Item Closed Size (cm)	Item / Master m <sup>3</sup>	Tube Size (ø)	Master Size a x b x c (cm)	Pcs. per Master	EAN
Jumbo 18324	100% Steel With Epoxy Powder Coating	Monoblock	7,38 / 16,3	154x96x43	43x125	43x161	0,063 / 0,126	25-51	17,5x164x44	2	8697435183242

Board

VIVA

18323



Metal Colours



Details

Item	Material	Surface Type	Weight Item / Master	Item Open Size a x b x c (cm)	Ironing Surface Size (cm)	Item Closed Size (cm)	m <sup>2</sup> Item / Master	Tube Size (ø)	Master Size a x b x c (cm)	Pcs. per Master	EAN EAN
Viva 18323	100% Steel with Epoxy Powder Coating	Monoblock	7,9 / 17,5	160x98x43	43x125	43x169	0,064 / 0,129	20x35-51	17x173x44	2	8697435183235



# PRESTIGE

18320

*Ironing*



Metal Colours



Details

Item	Material	Surface Type	Weight Item / Master	Item Open Size a x b x c (cm)	Ironing Surface Size (cm)	Item Closed Size (cm)	m <sup>3</sup> Item / Master	Tube Size (ø)	Master Size a x b x c (cm)	Pcs. per Master	EAN
Prestige 18320	100% Steel With Epoxy Powder Coating	Mesh	6,5 / 15,95	157x95x43	42x125	42x175	0,054 / 0,108	28	14x175,5x44,2	2	8697435183204

Board

# FOCUS

18315



Metal Colours



Item	Material	Surface Type	Weight Item / Master	Item Open Size a x b x c (cm)	Ironing Surface Size (cm)	Item Closed Size (cm)	m <sup>2</sup> Item / Master	Tube Size (ø)	Master Size a x b x c (cm)	Pcs. per Master	EAN EAN
Focus 18315	100% Steel with Epoxy Powder Coating	Monoblock	5,78 / 13,02	142x95x41	38x118	41x158	0,048 / 0,097	25-38	14,5x159,5x42	2	8697435183150

# DREAM

18318

*Ironing*



Metal Colours



Item	Material	Surface Type	Weight Item / Master	Item Open Size a x b x c (cm)	Ironing Surface Size (cm)	Item Closed Size (cm)	Item / Master m <sup>3</sup>	Tube Size (a)	Master Size a x b x c (cm)	Pcs. per Master	EAN
Dream 18318	100% Steel With Epoxy Powder Coating	Monoblock	5,08 / 11,64	142x95x41	40x118	41x158	0,048 / 0,097	25-38	14,5x159,5x42	2	8697435183181

Board

# CAPITOL

18304



Metal Colours



Item	Material	Surface Type	Weight Item / Master	Item Open Size a x b x c (cm)	Ironing Surface Size (cm)	Item Closed Size (cm)	m <sup>2</sup> Item / Master	Tube Size (e)	Master Size a x b x c (cm)	Pcs. per Master	EAN EAN
Capitol 18304	100% Steel with Epoxy Powder Coating	Mesh	5,92 / 13,3	154,5x98x41	38x120	41x166	0,048 / 0,097	20x35-38	14x166,5x42	2	8697435183044



# CARINO

18301

*Ironing*



### Metal Colours



Item	Material	Surface Type	Weight Item / Master	Item Open Size a x b x c (cm)	Ironing Surface Size (cm)	Item Closed Size (cm)	Item / Master m <sup>3</sup>	Tube Size (ø)	Master Size a x b x c (cm)	Pcs. per Master	EAN
Carino 18301	100% Steel With Epoxy Powder Coating	Monoblock	5,65 / 13,7	141x92x38	38x118	38x158	0,044 / 0,088	25	15x159,5x39,5	2	8697435183013

Board

MAGIC

18325



Metal Colours



Item	Material	Surface Type	Weight Item / Master	Item Open Size a x b x c (cm)	Ironing Surface Size (cm)	Item Closed Size (cm)	Item / Master m <sup>2</sup>	Tube Size (e)	Master Size a x b x c (cm)	Pcs. per Master	EAN EAN
Magic 18325	100% Steel with Epoxy Powder Coating	Monoblock	5,9 / 12,6	143x93x40,5	38x118	39x159	0,048 / 0,097	25-38	14,5x159,5x42	2	8697435183259

# ATOS

18340

*Ironing*



### Metal Colours



Item	Material	Surface Type	Weight Item / Master	Item Open Size a x b x c (cm)	Ironing Surface Size (cm)	Item Closed Size (cm)	Item / Master m <sup>3</sup>	Tube Size (ø)	Master Size a x b x c (cm)	Pcs. per Master	EAN
Atos 18340	100% Steel With Epoxy Powder Coating	Monoblock	5,08 / 11,5	135x94x41	36x112	41x158	0,048 / 0,097	25-38	14,5x159,5x42	2	8697435183402

Board

ARES

18367



Metal Colours



Item	Material	Surface Type	Weight Item / Master	Item Open Size a x b x c (cm)	Ironing Surface Size (cm)	Item Closed Size (cm)	Item / Master m <sup>3</sup>	Tube Size (e)	Master Size a x b x c (cm)	Pcs. per Master	EAN EAN
Ares 18367	100% Steel with Epoxy Powder Coating	Monoblock	4,44 / 19,46	133,5x93x43,5	36x112	43,5x157	0,041 / 0,167	21-38	23,5x158x45	4	8697435183679



# ADA

18369

*Ironing*



### Metal Colours



Item	Material	Surface Type	Weight Item / Master	Item Open Size a x b x c (cm)	Ironing Surface Size (cm)	Item Closed Size (cm)	Item / Master m <sup>3</sup>	Tube Size (ø)	Master Size a x b x c (cm)	Pcs. per Master	EAN
Ada 18369	100% Steel With Epoxy Powder Coating	Mesh	4,46 / 10,42	142x94x41	38x120	41x158	0,048 / 0,097	25-38	14,5x159,5x42	2	8697435183693

Board

# DINAMIC

18355



Metal Colours



Item	Material	Surface Type	Weight Item / Master	Item Open Size a x b x c (cm)	Ironing Surface Size (cm)	Item Closed Size (cm)	Item / Master m <sup>2</sup>	Tube Size (ø)	Master Size a x b x c (cm)	Pcs. per Master	EAN EAN
Dinamic 18355	100% Steel with Epoxy Powder Coating	Monoblock	4,42 / 19,32	132x92x33	33x110	33x154	0,029 / 0,117	21-32	20x156x37,5	4	8697435183556

# SERA

18368

*Ironing*



## Metal Colours



Item	Material	Surface Type	Weight Item / Master	Item Open Size a x b x c (cm)	Ironing Surface Size (cm)	Item Closed Size (cm)	Item / Master m <sup>3</sup>	Tube Size (ø)	Master Size a x b x c (cm)	Pcs. per Master	EAN
Sera 18368	100% Steel With Epoxy Powder Coating	Mesh	4,4 / 18,4	135x93x41	34x114	41x156	0,083 / 0,167	21-38	23,5x158x45	4	8697435183686

Board

**BONUS**

18346



Metal Colours



Item	Material	Surface Type	Weight Item / Master	Item Open Size a x b x c (cm)	Ironing Surface Size (cm)	Item Closed Size (cm)	Item / Master m <sup>2</sup>	Tube Size (e)	Master Size a x b x c (cm)	Pcs. per Master	EAN EAN
<b>Bonus</b> 18346	100% Steel with Epoxy Powder Coating	Mesh	4,34 / 18,64	134x90x36	38x110	38x151	0,027 / 0,109	25	18x152x40	4	8697435183464

# IDEAL

18356

*Ironing*



### Metal Colours



Item	Material	Surface Type	Weight Item / Master	Item Open Size a x b x c (cm)	Ironing Surface Size (cm)	Item Closed Size (cm)	Item / Master m <sup>3</sup>	Tube Size (ø)	Master Size a x b x c (cm)	Pcs. per Master	EAN
Item <b>Ideal</b> 18356	100% Steel With Epoxy Powder Coating	Monoblock	3,76 / 16	131x89x34	33x110	34x146	0,025 / 0,100	21	19x147x36	4	8697435183563

Board

# AQUA 25

18349



### Metal Colours



Item	Material	Surface Type	Weight Item / Master	Item Open Size a x b x c (cm)	Ironing Surface Size (cm)	Item Closed Size (cm)	Item / Master m <sup>2</sup>	Tube Size (e)	Master Size a x b x c (cm)	Pcs. per Master	EAN EAN
Aqua 25 18349	100% Steel with Epoxy Powder Coating	Mesh	4,2 / 9,64	142x93x38	38x120	38x157	0,033 / 0,066	25	10,5x158,5x40	2	8697435183495



# AQUA 21

18364

*Ironing*



### Metal Colours



Item	Material	Surface Type	Weight Item / Master	Item Open Size a x b x c (cm)	Ironing Surface Size (cm)	Item Closed Size (cm)	Item / Master m <sup>3</sup>	Tube Size (ø)	Master Size a x b x c (cm)	Pcs. per Master	EAN
Aqua 21 18364	100% Steel with Epoxy Powder Coating	Mesh	3,8 / 10,3	142x91x38	38x120	38x157,5	0,033 / 0,066	21	10,5x158,5x40	2	8697435183648

Board

# DIAMOND

18366



### Metal Colours



Item	Material	Surface Type	Weight Item / Master	Item Open Size a x b x c (cm)	Ironing Surface Size (cm)	Item Closed Size (cm)	Item m <sup>2</sup> Item / Master	Tube Size (e)	Master Size a x b x c (cm)	Pcs. per Master	EAN EAN
Diamond 18366	100% Steel with Epoxy Powder Coating	Monoblock	3,92 / 17,3	131x92x33	33x110	33x152,5	0,029 / 0,117	19-32	20x156x37,5	4	8697435183662

# POWER

18347

*Ironing*



### Metal Colours



Item	Material	Surface Type	Weight Item / Master	Item Open Size a x b x c (cm)	Ironing Surface Size (cm)	Item Closed Size (cm)	Item / Master m <sup>3</sup>	Tube Size (ø)	Master Size a x b x c (cm)	Pcs. per Master	EAN
Power 18347	100% Steel With Epoxy Powder Coating	Mesh	3,62 / 16,16	130x89x38	38x110	38x146	0,024 / 0,099	21	17x147x40	4	8697435183471

Board

# BASIC

18343



Metal Colours



Item	Material	Surface Type	Weight Item / Master	Item Open Size a x b x c (cm)	Ironing Surface Size (cm)	Item Closed Size (cm)	Item / Master m <sup>2</sup>	Tube Size (e)	Master Size a x b x c (cm)	Pcs. per Master	EAN EAN
Basic 18343	100% Steel with Epoxy Powder Coating	Mesh	3,92 / 16,88	131x92x33	33x110	33x155	0,029 / 0,117	21-32	20x156x37,5	4	8697435183433

# BRAVA

18344

*Ironing*



### Metal Colours



Item	Material	Surface Type	Weight Item / Master	Item Open Size a x b x c (cm)	Ironing Surface Size (cm)	Item Closed Size (cm)	Item / Master m <sup>3</sup>	Tube Size (ø)	Master Size a x b x c (cm)	Pcs. per Master	EAN
Brava 18344	100% Steel With Epoxy Powder Coating	Mesh	3,4 / 14,6	131x88x34,5	33x110	35x146,5	0,022 / 0,088	21	17x147x35,5	4	8697435183440

Board

ONE

18358



Metal Colours



Item	Material	Surface Type	Weight Item / Master	Item Open Size a x b x c (cm)	Ironing Surface Size (cm)	Item Closed Size (cm)	Item m <sup>2</sup> Item / Master	Tube Size (ø)	Master Size a x b x c (cm)	Pcs. per Master	EAN
One 18358	100% Steel with Epoxy Powder Coating	Mesh	2,9 / 19,22	126x88x33	30x105	33x145	0,020 / 0,122	19	24,5x146,5x34	6	8697435183587



# MINI ONE

18359

*Ironing*



### Metal Colours



Item	Material	Surface Type	Weight Item / Master	Item Open Size a x b x c (cm)	Ironing Surface Size (cm)	Item Closed Size (cm)	Item / Master m <sup>3</sup>	Tube Size (ø)	Master Size a x b x c (cm)	Pcs. per Master	EAN
Mini One 18359	100% Steel With Epoxy Powder Coating	Mesh	2,6 / 17,5	110x81x30	30x90	30x120	0,018 / 0,109	19	28,5x124x31	6	8697435183594

Board

# TABLE TOP

18360

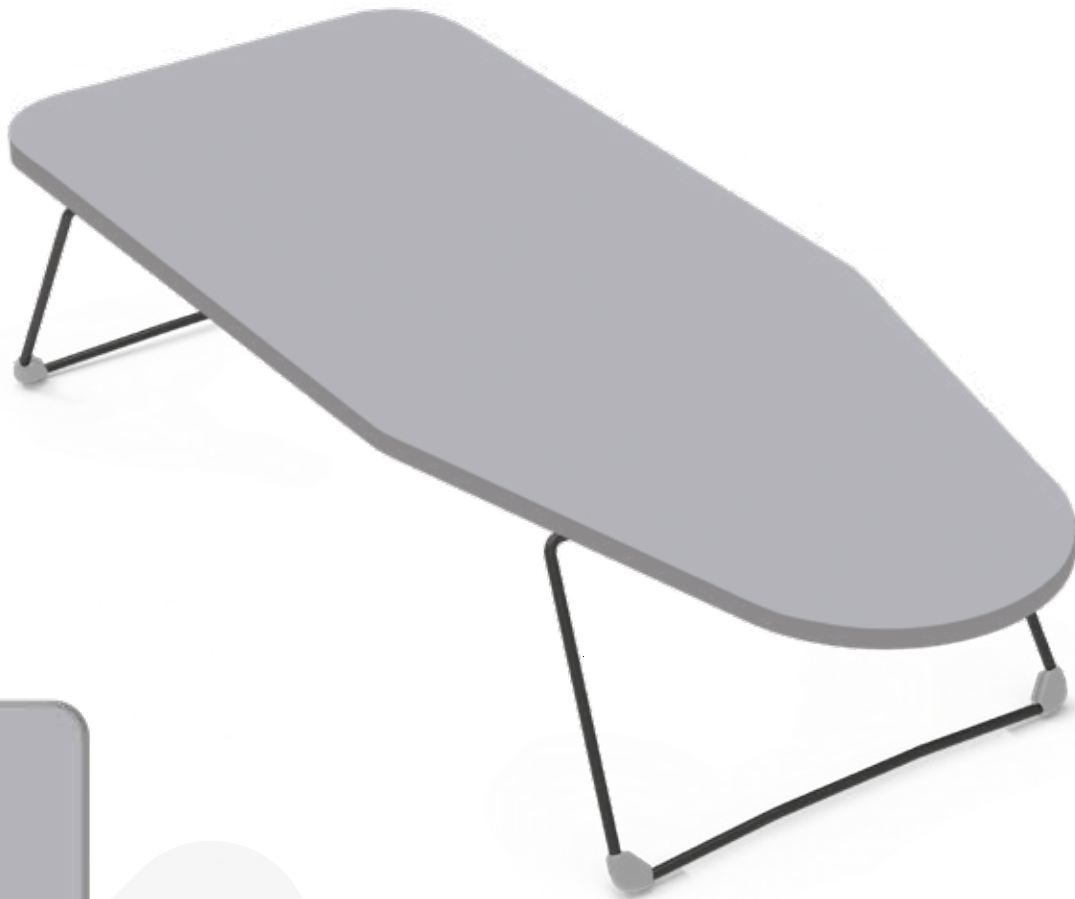

Metal Colours





Item	Material	Surface Type	Weight Item / Master	Item Open Size a x b x c (cm)	Ironing Surface Size (cm)	Item Closed Size (cm)	Item / Master m <sup>2</sup>	Wire Size (e)	Master Size a x b x c (cm)	Pcs. per Master	EAN EAN
Table Top 18359	100% Steel with Epoxy Powder Coating	Mesh	1,04 / 11,82	74x17x30	30x74	30x74	0,006 / 0,064	6	30x75x28,5	10	8697435183600

# Tube

## DETAILS

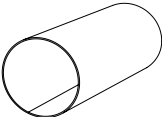
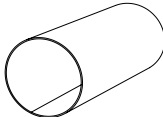
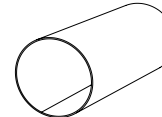
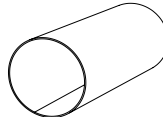
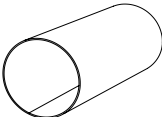
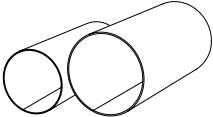
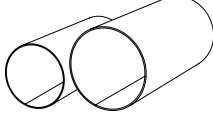
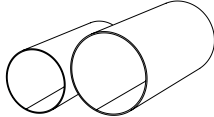
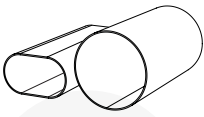
Tube

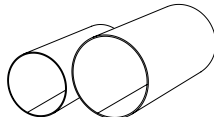
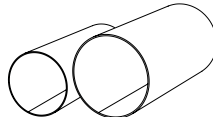
<p><b>A</b></p>  <p>Ø 6</p> <p>18360 TABLE TOP</p>	<p><b>B</b></p>  <p>Ø 19</p> <p>18358 ONE 18359 MINI ONE</p>	<p><b>C</b></p>  <p>Ø 21</p> <p>18344 BRAVA 18347 POWER 18356 IDEAL 18364 AQUA 21</p>	<p><b>D</b></p>  <p>Ø 25</p> <p>18301 CARINO 18346 BONUS 18349 AQUA 25</p>
<p><b>E</b></p>  <p>Ø 28</p> <p>18320 PRESTIGE</p>	<p><b>F</b></p>  <p>Ø 19-32</p> <p>18366 DIAMOND</p>	<p><b>G</b></p>  <p>Ø 25-38</p> <p>18315 FOCUS 18318 DREAM 18325 MAGIC 18340 ATOS 18369 ADA</p>	<p><b>H</b></p>  <p>Ø 21-32</p> <p>18343 BASIC 18355 DINAMIC</p>
<p><b>I</b></p>  <p>Ø 20x35-51</p> <p>18323 VIVA 18326 MONDO 18327 MONO MONDO</p>	<p><b>J</b></p>  <p>Ø 20x35-38</p> <p>18304 CAPITOL</p>	<p><b>K</b></p>  <p>Ø 25-51</p> <p>18324 JUMBO</p>	<p><b>L</b></p>  <p>Ø 21-38</p> <p>18367 ARES 18368 SERA</p>

Table

Table

# DETAILS

**A**

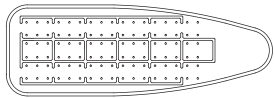

**43x125 CM**

18323 VIVA  
18324 JUMBO  
18327 MONO MONDO

**B**

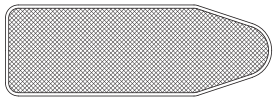

**42x125 CM**

18320 PRESTIGE  
18326 MONDO

**C**

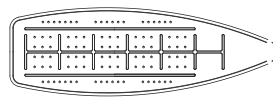

**40x118 CM**

18318 DREAM

**D**

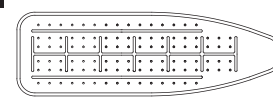

**38x118 CM**

18301 CARINO  
18315 FOCUS

**E**

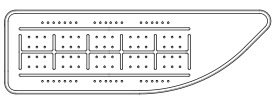

**38x118 CM**

18325 MAGIC

**F**

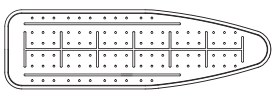

**33x110 CM**

18355 DINAMIC  
18356 IDEAL  
18366 DIAMOND

**G**

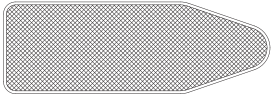

**38x110 CM**

18346 BONUS  
18347 POWER

**H**

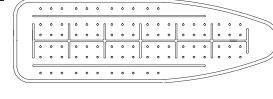

**36x112 CM**

18340 ATOS  
18367 ARES

**I**

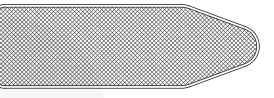

**38x120 CM**

18304 CAPITOL  
18349 AQUA 25  
18364 AQUA 21  
18369 ADA

**K**

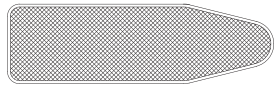

**33x110 CM**

18343 BASIC  
18344 BRAVA

**L**

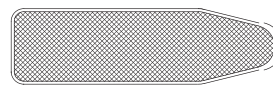

**30x105 CM**

18358 ONE

**M**

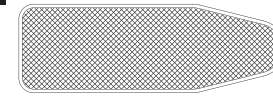

**30x90 CM**

18359 MINI ONE

**N**



**30x74 CM**

18360 TABLE TOP

**O**

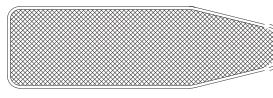

**34x114 CM**

18368 SERA

# Iron Rest

## DETAILS

Iron Rest

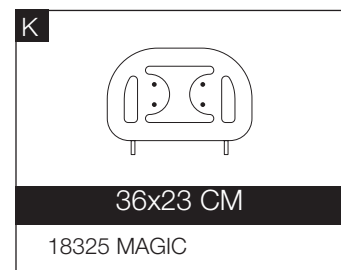
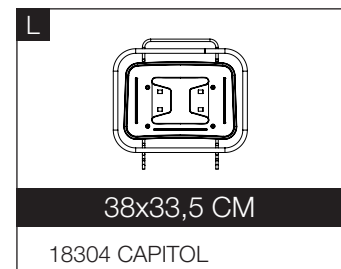
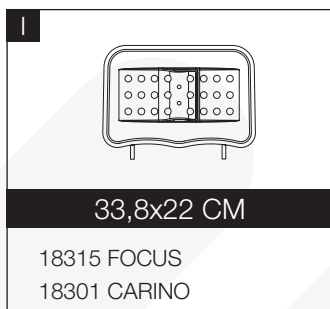
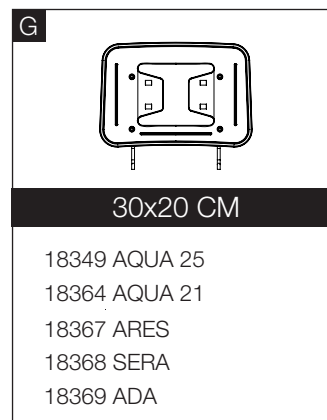
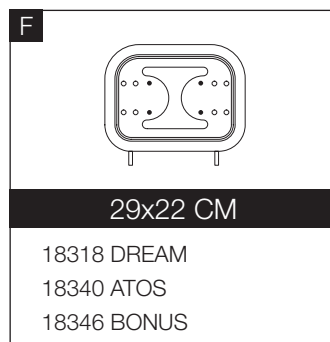
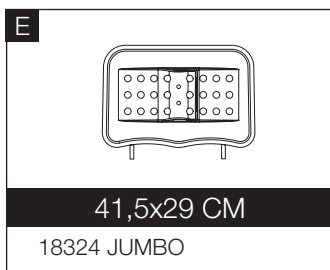
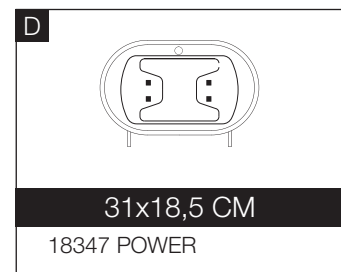
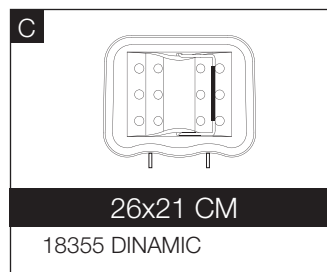
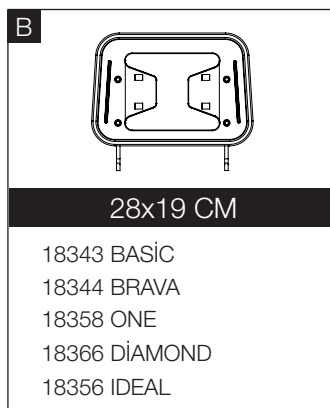
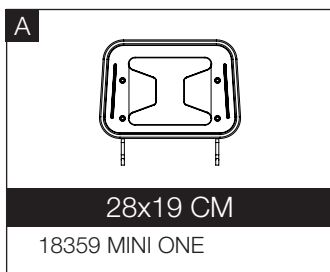



# DETAILS

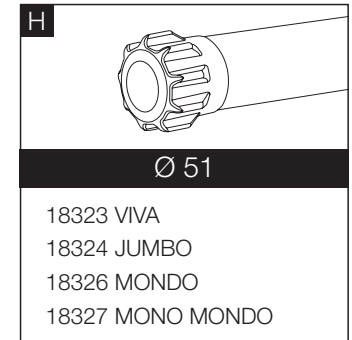
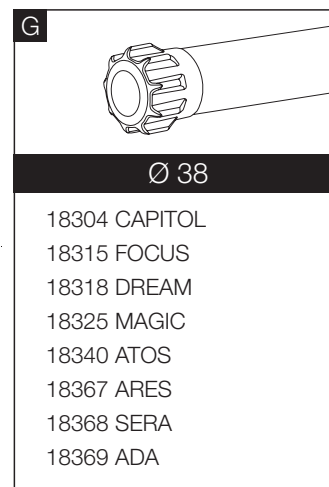
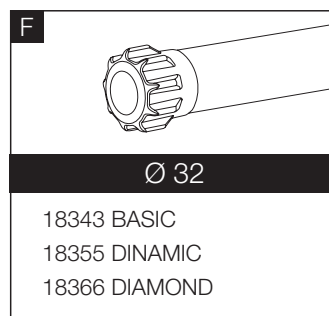
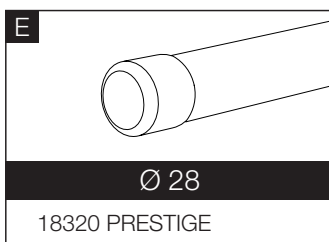
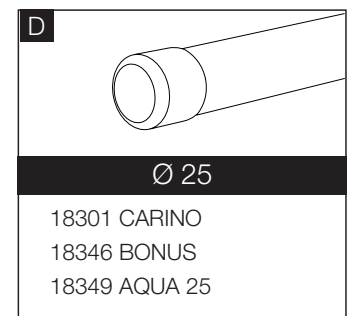
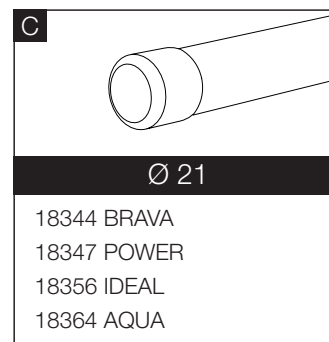
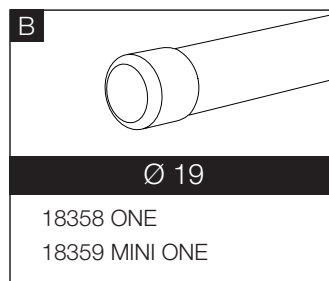
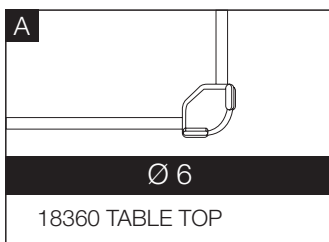

# Fabric

## DETAILS

# Fabric



CB-015



CB-111



CB-112



CB-113



CB-114



CB-126

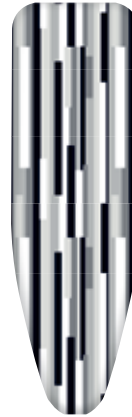

CB-143



CB-144



CB-157



CB-175



CB-180



CB-183



CB-184



CB-192



CB-197



CA-203



CB-205

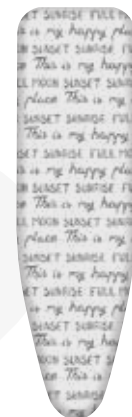

CB-209



CB-213



CA-217



CB-218



# Details



CB-219



CB-220



CB-221



CB-224



CB-227



CB-228



CB-229



CB-230



CB-231



CB-234



CB-242



CB-243



CB-244

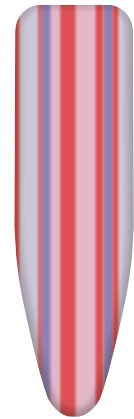

CB-245



CB-248

Clothes



*Dryers*



# STREAM /4

18139

*Clothes*

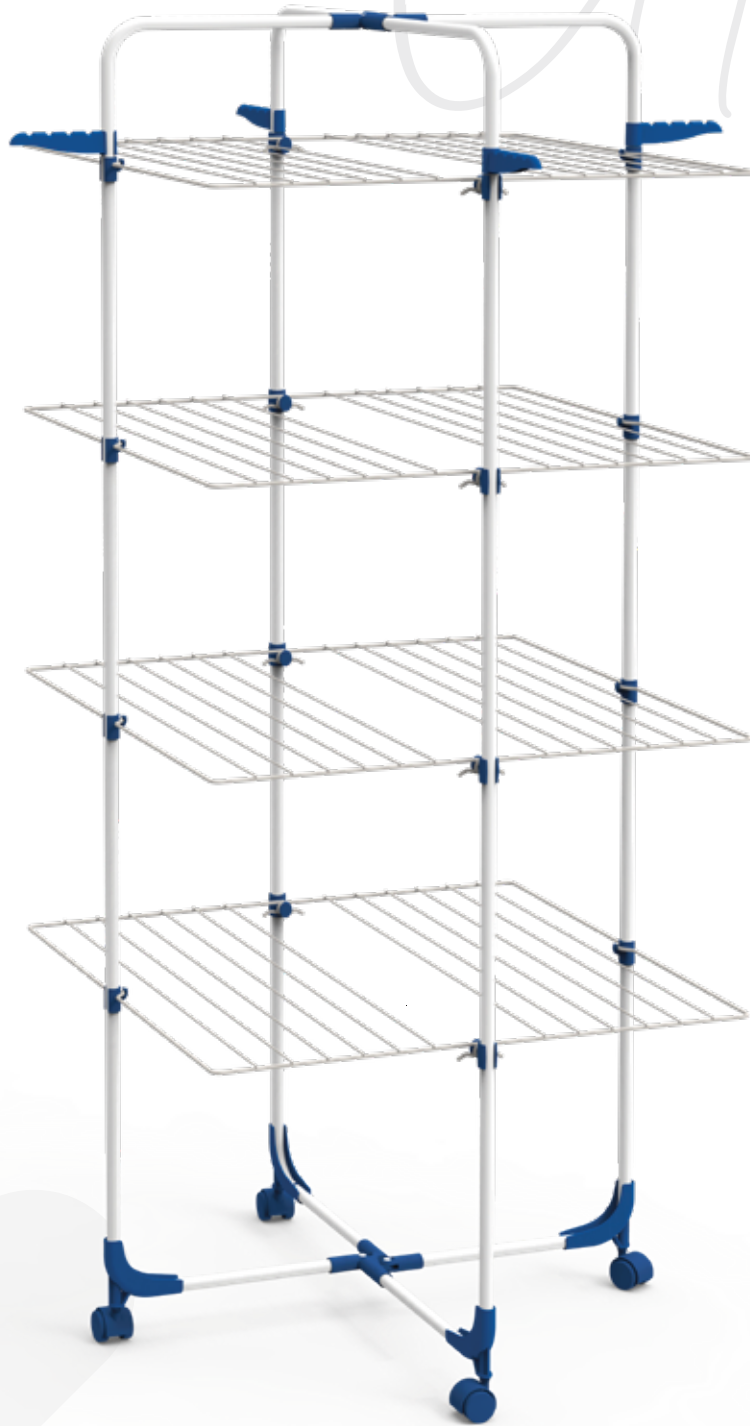

Details

Item	Material	Weight Item / Master	Item Open Size a x b x c (cm)	Hanging Capacity (m)	Item Closed Size (cm)	Item m <sup>3</sup> Item / Master	Tube Size (ø)	Master Size a x b x c (cm)	Pcs. per Master	EAN
Stream 4 18139	100% Steel with Epoxy Powder Coating	4,74 / 20,3	70x70x164	40	70x164	0,051 / 0,199	16	17x167x72,5	4	8697435181392

# STREAM 3

18138

Dryer



Details

Item	Material	Weight Item / Master	Item Open Size a x b x c (cm)	Hanging Capacity (m)	Item Closed Size (cm)	Item m <sup>3</sup> / Master	Tube Size (ø)	Master Size a x b x c (cm)	Pcs. per Master	EAN
Stream 3 18138	100% Steel with Epoxy Powder Coating	3,7 / 16,4	70x70x129	30	70x129	0,040 / 0,161	16	17x130,8x72,5	4	8697435181385

# STREAM /2

18137

*Clothes*



Details

Item	Material	Weight Item / Master	Item Open Size a x b x c (cm)	Hanging Capacity (m)	Item Closed Size (cm)	m <sup>3</sup> Item / Master	Tube Size (ø)	Master Size a x b x c (cm)	Pcs. per Master	EAN
Stream 2 18137	100% Steel with Epoxy Powder Coating	2,5 / 10	70x70x94	20	70x90	0,027 / 0,110	16	17x91x71,5	4	8697435181378



# ISTANBUL LUX

18142

Dryer



Item	Material	Weight Item / Master	Item Open Size a x b x c (cm)	Hanging Capacity (m)	Item Closed Size (cm)	Item m <sup>3</sup> Master	Tube Size (ø)	Master Size a x b x c (cm)	Pcs. per Master	EAN
Istanbul LUX 18142	100% Steel with Epoxy Powder Coating	3,2 / 20,1	177x51,5x107,5	18	54,5x132	0,021 / 0,128	14-16	16x132x62	6	8697435181422



# WINGS LUX

18111

*Clothes*

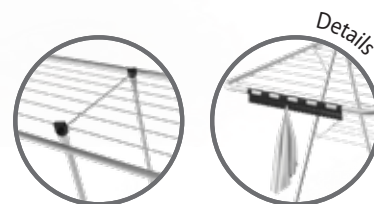
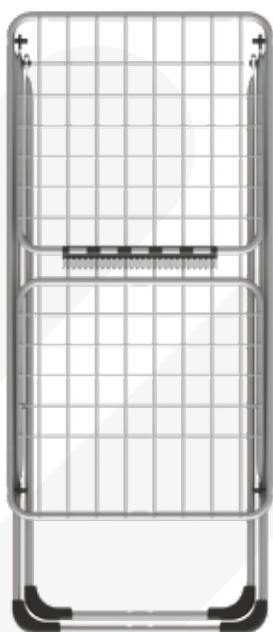

Item	Material	Weight Item / Master	Item Open Size a x b x c (cm)	Hanging Capacity (m)	Item Closed Size (cm)	Item m <sup>3</sup> Master	Tube Size (ø)	Master Size a x b x c (cm)	Pcs. per Master	EAN
Wings LUX 18111	100% Steel with Epoxy Powder Coating	3,5 / 22,12	177x55x100,5	18	55x130,5	0,021 / 0,130	16	16x132x62	6	8697435181118

Dryer

# HERO

18111-01

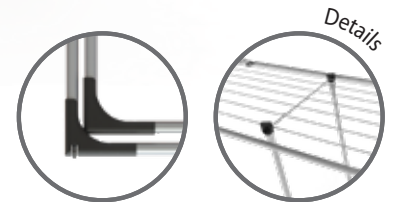

Item	Material	Weight Item / Master	Item Open Size a x b x c (cm)	Hanging Capacity (m)	Item Closed Size (cm)	Item m <sup>3</sup> / Master	Tube Size (ø)	Master Size a x b x c (cm)	Pcs. per Master	EAN
Hero 18111-01	100% Steel with Epoxy Powder Coating	4,28 / 26,8	174,5x55x107	18	55x130	0,026 / 0,161	16	21x134x57,5	6	8697435811114

# WINGS BODRUM

18109

*Clothes*

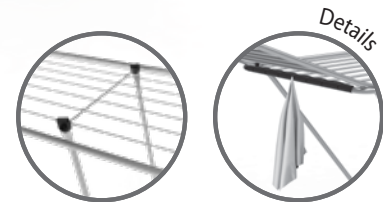
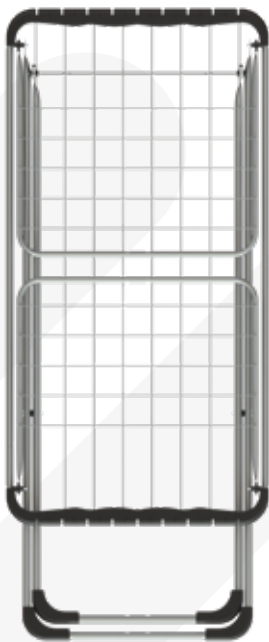

Item	Material	Weight Item / Master	Item Open Size a x b x c (cm)	Hanging Capacity (m)	Item Closed Size (cm)	m <sup>3</sup> Item / Master	Tube Size (ø)	Master Size a x b x c (cm)	Pcs. per Master	EAN
Wings Bodrum 18109	100% Steel with Epoxy Powder Coating	2,90 / 17,95	182x55x105	18	55x129	0,022 / 0,131	12-14-16	16x132x62	6	8697435181095

Dryer

# FANTASY LUX

18124-01

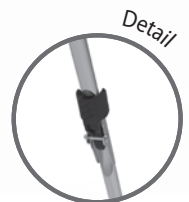
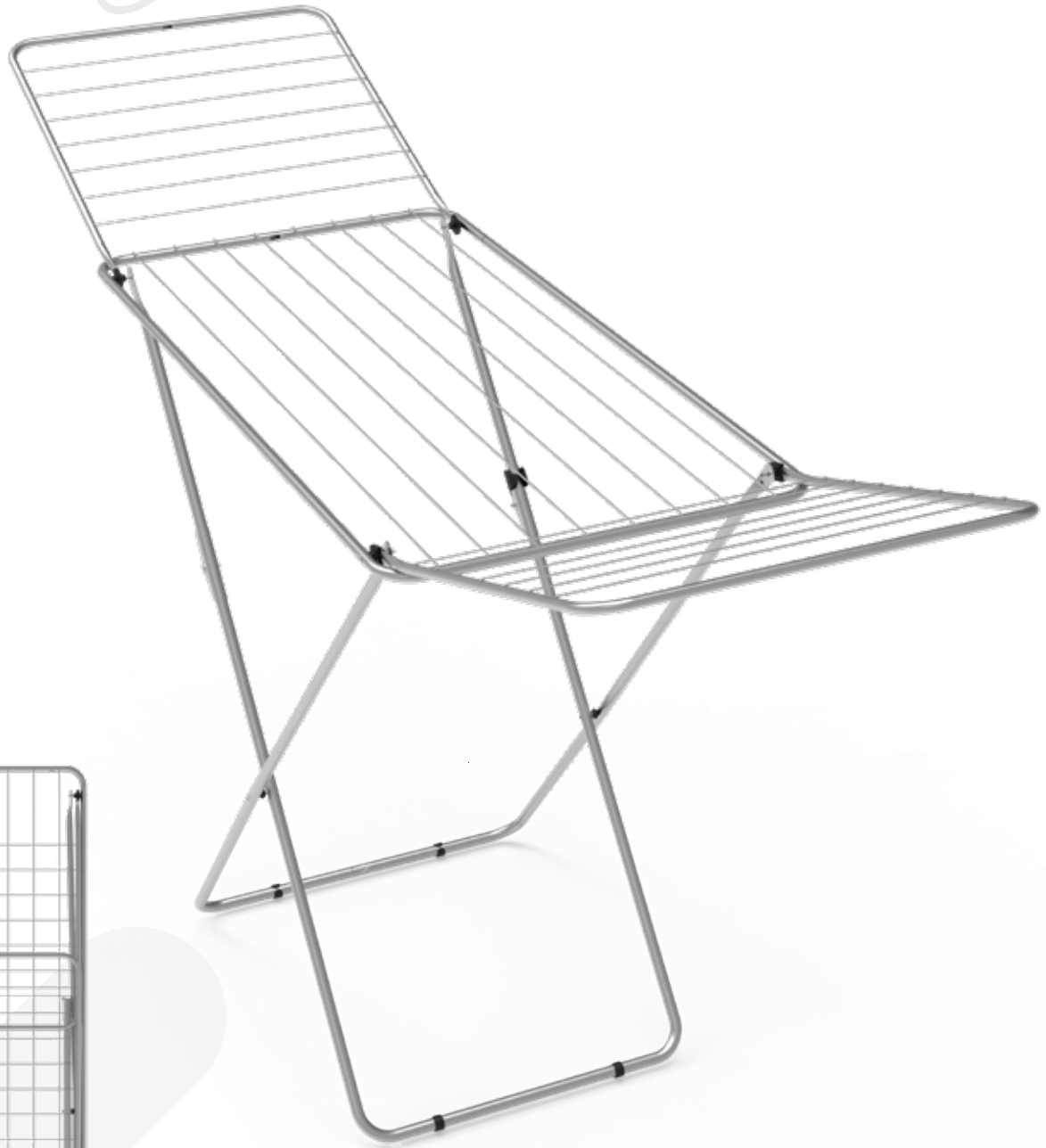

Item	Material	Weight Item / Master	Item Open Size a x b x c (cm)	Hanging Capacity (m)	Item Closed Size (cm)	Item m <sup>3</sup> / Master	Tube Size (ø)	Master Size a x b x c (cm)	Pcs. per Master	EAN
Fantasy LUX 18124-01	100% Steel with Epoxy Powder Coating	2,8 / 16,6	198,5x55x110	20	55x129,5	0,031 / 0,19	12-14-16	26x131x56	6	8697435811244

# FANTASY

18124

*Clothes*

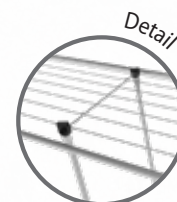
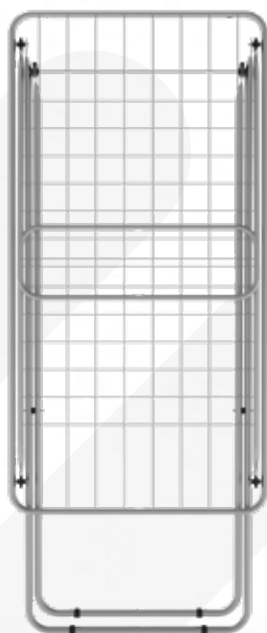
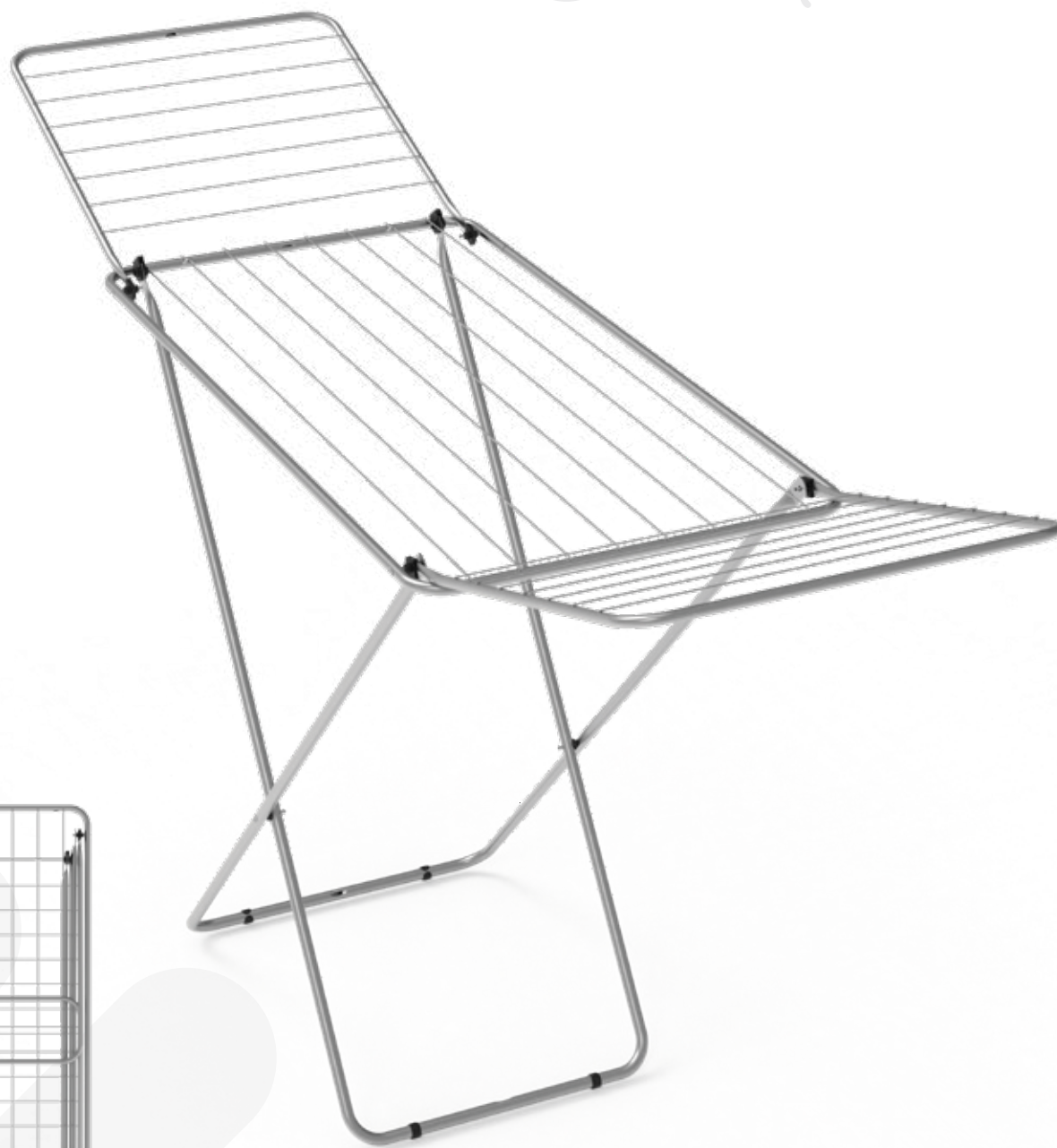

Item	Material	Weight Item / Master	Item Open Size a x b x c (cm)	Hanging Capacity (m)	Item Closed Size (cm)	m <sup>3</sup> Item / Master	Tube Size (ø)	Master Size a x b x c (cm)	Pcs. per Master	EAN
Fantasy 18124	100% Steel with Epoxy Powder Coating	2,44 / 15,86	196x55x108	20	55x128,5	0,023 / 0,143	12-14-16	18x129,5x61,5	6	8697435181248



Dryer

# AEGEANSTAR LUX

18120-01

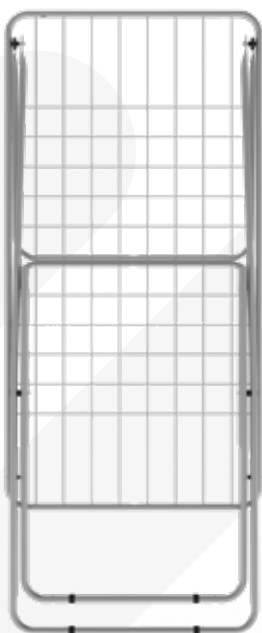
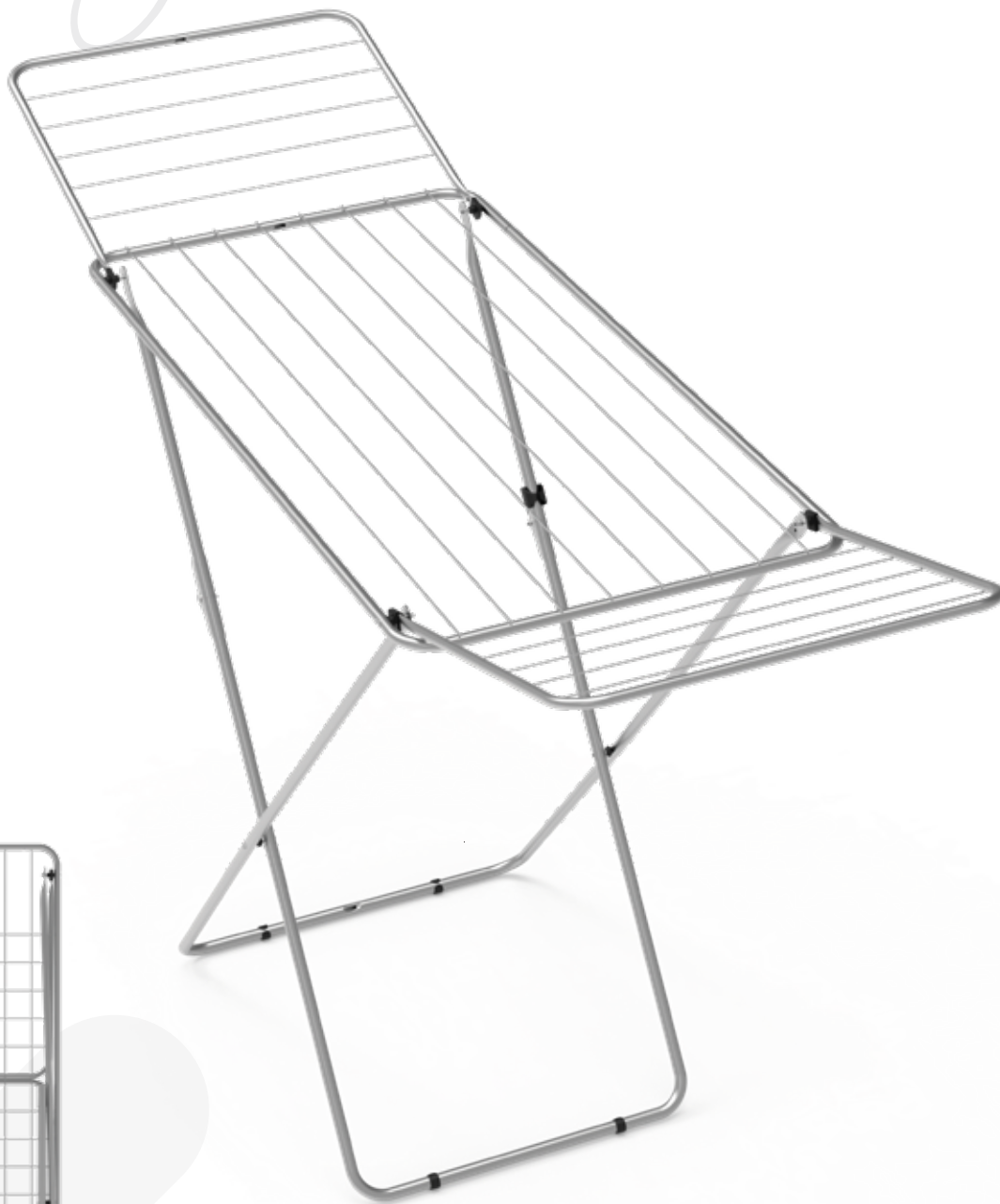

Item	Material	Weight Item / Master	Item Open Size a x b x c (cm)	Hanging Capacity (m)	Item Closed Size (cm)	m <sup>3</sup> Item / Master	Tube Size (ø)	Master Size a x b x c (cm)	Pcs. per Master	EAN
Aegeanstar Lüx 18120-01	100% Steel with Epoxy Powder Coating	2,48 / 15,86	182x55x102	18	55x128	0,017 / 0,107	12-14-16	13,5x129,5x61,5	6	8697435811206

# AEGEANSTAR

18120

*Polites*

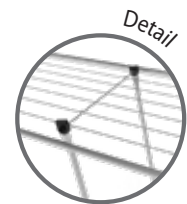
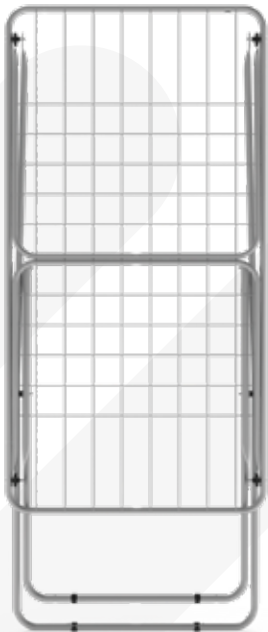
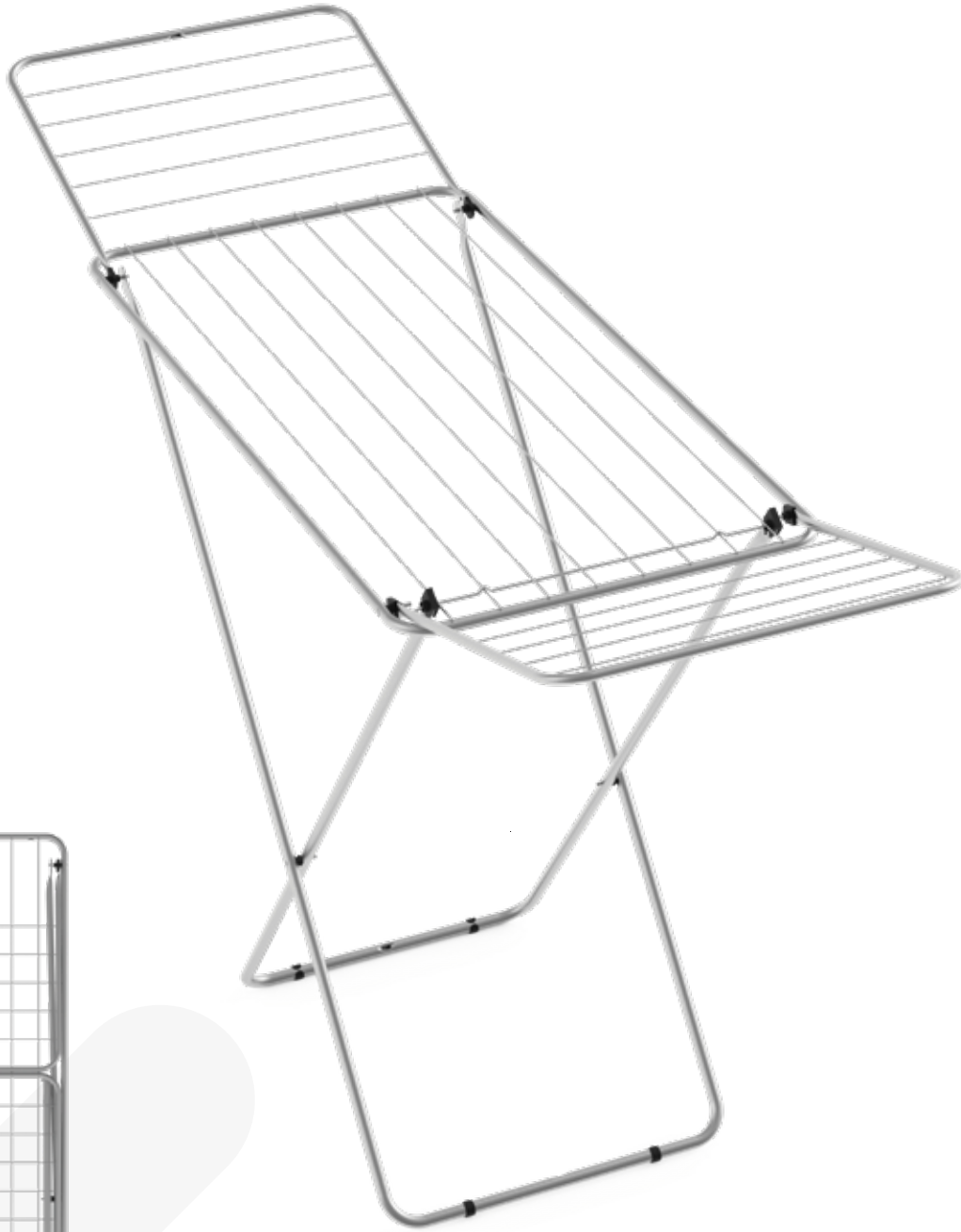

Item	Material	Weight Item / Master	Item Open Size a x b x c (cm)	Hanging Capacity (m)	Item Closed Size (cm)	m <sup>3</sup> Item / Master	Tube Size (ø)	Master Size a x b x c (cm)	Pcs. per Master	EAN
Aegeanstar 18120	100% Steel with Epoxy Powder Coating	2,38 / 15,9	182x55x102	18	55x128	0,017 / 0,107	12-14-16	13,5x129,5x61,5	6	8697435181200

Dryer

STAR

18121

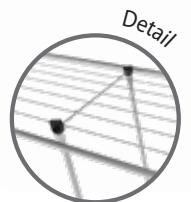
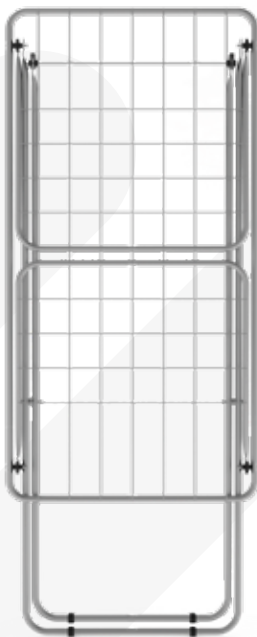

Item	Material	Weight Item / Master	Item Open Size a x b x c (cm)	Hanging Capacity (m)	Item Closed Size (cm)	m <sup>3</sup> Item / Master	Tube Size (ø)	Master Size a x b x c (cm)	Pcs. per Master	EAN
Star 18121	100% Steel with Epoxy Powder Coating	2,18 / 13,68	163,5x46x96,5	16	50x123,5	0,015 / 0,093	12-14-14	14,5x125x51,5	6	8697435181217



# UNO

18110

Clothes

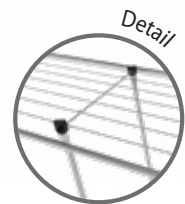
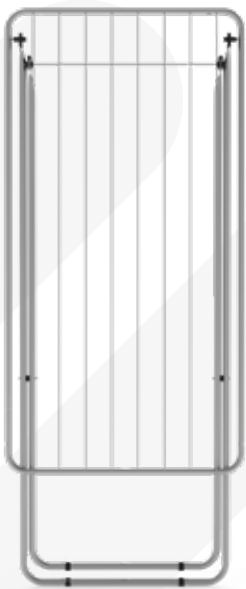

Item	Material	Weight Item / Master	Item Open Size a x b x c (cm)	Hanging Capacity (m)	Item Closed Size (cm)	m <sup>3</sup> Item / Master	Tube Size (ø)	Master Size a x b x c (cm)	Pcs. per Master	EAN
Uno 18110	100% Steel with Epoxy Powder Coating	2,1 / 13,75	106x54,5x92,5	10	54,5x131,5	0,019 / 0,11	14-16	16x130x56	6	8697435181101

# FLEXY 220

18133

*Dryer*

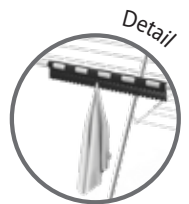
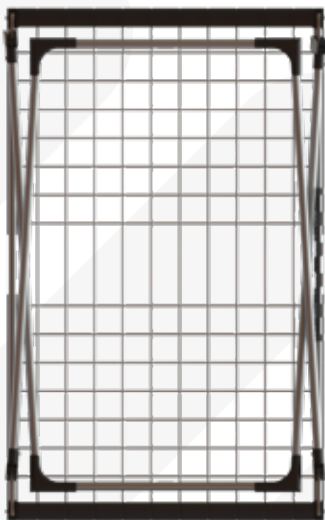

Item	Material	Weight Item / Master	Item Open Size a x b x c (cm)	Hanging Capacity (m)	Item Closed Size (cm)	m <sup>3</sup> Item / Master	Tube Size (ø)	Master Size a x b x c (cm)	Pcs. per Master	EAN
Flexy 220 18133	100% Steel with Epoxy Powder Coating	4,45 / 19,4	186x66,5x107	22	66,5x107	0,058 / 0,234	16-19	31,5x108,5x68,5	4	8697435181330

# FLEXY 160

18132

*Clothes*



Item	Material	Weight Item / Master	Item Open Size a x b x c (cm)	Hanging Capacity (m)	Item Closed Size (cm)	m <sup>3</sup> Item / Master	Tube Size (ø)	Master Size a x b x c (cm)	Pcs. per Master	EAN
Flexy 160 18132	100% Steel with Epoxy Powder Coating	3,85 / 17,35	177x54x107	16	54x101	0,044 / 0,178	16-19	31,5x99,5x57	4	8697435181323

Dryer

# COSMOS

18130



Item	Material	Weight Item / Master	Item Open Size a x b x c (cm)	Hanging Capacity (m)	Item Closed Size (cm)	m <sup>3</sup> Item / Master	Tube Size (ø)	Master Size a x b x c (cm)	Pcs. per Master	EAN
Cosmos 18130	100% Steel with Epoxy Powder Coating	3,18 / 20,84	160x54x130	20	60x101	0,035 / 0,212	16	33x104x62	6	8697435181309

# SMART

18128

*Clothes*

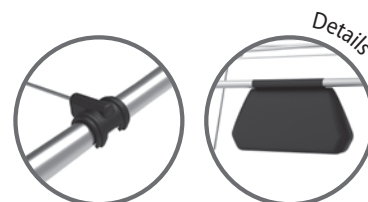

Item	Material	Weight Item / Master	Item Open Size a x b x c (cm)	Hanging Capacity (m)	Item Closed Size (cm)	m <sup>3</sup> Item / Master	Tube Size (ø)	Master Size a x b x c (cm)	Pcs. per Master	EAN
Smart 18128	100% Steel with Epoxy Powder Coating	2,9 / 18,48	167x49,5x97	16	54,5x98	0,297 / 0,178	16	31,5x99,5x57	6	8697435181286

Dryer

# FLORA

18117

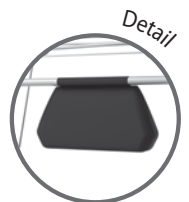

Item	Material	Weight Item / Master	Item Open Size a x b x c (cm)	Hanging Capacity (m)	Item Closed Size (cm)	m <sup>3</sup> Item / Master	Tube Size (ø)	Master Size a x b x c (cm)	Pcs. per Master	EAN
Flora 18117	100% Steel with Epoxy Powder Coating	2,4 / 15,42	161,5x49,5x116	16	55x98,5	0,029 / 0,178	14	31,5x99,5x57	6	8697435181170

# HANDY

18116

*Clothes*



Item	Material	Weight Item / Master	Item Open Size a x b x c (cm)	Hanging Capacity (m)	Item Closed Size (cm)	m <sup>3</sup> Item / Master	Tube Size (ø)	Master Size a x b x c (cm)	Pcs. per Master	EAN
Handy 18116	100% Steel with Epoxy Powder Coating	3,22 / 21,54	173,5x54,5x119,5	20	59,5x102	0,295 / 0,177	16	27,5x104x62	6	8697435181163



# CAPRI LUX

18105

Dryer

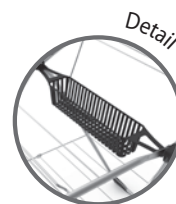

Item	Material	Weight Item / Master	Item Open Size a x b x c (cm)	Hanging Capacity (m)	Item Closed Size (cm)	m <sup>3</sup> Item / Master	Tube Size (ø)	Master Size a x b x c (cm)	Pcs. per Master	EAN EAN
Capri LUX 18105	100% Steel with Epoxy Powder Coating	3,1 / 19,61	176x54,5x117,5	20	59x102	0,029 / 0,177	16	27,5x104x62	6	8697435181057



# CAPRI

18101

*Clothes*



Item	Material	Weight Item / Master	Item Open Size a x b x c (cm)	Hanging Capacity (m)	Item Closed Size (cm)	m <sup>3</sup> Item / Master	Tube Size (ø)	Master Size a x b x c (cm)	Pcs. per Master	EAN
Capri 18101	100% Steel with Epoxy Powder Coating	2,88 / 19,14	176x54,5x117,5	20	59x102	0,295 / 0,177	16	27,5x104x62	6	8697435181019

Dryer

# JUNIOR

18114



Item	Material	Weight Item / Master	Item Open Size a x b x c (cm)	Hanging Capacity (m)	Item Closed Size (cm)	m <sup>3</sup> Item / Master	Tube Size (ø)	Master Size a x b x c (cm)	Pcs. per Master	EAN
Junior 18114	100% Steel with Epoxy Powder Coating	2,02 / 13,98	146x49,5x131,5	16	54x98	0,025 / 0,150	14	26,5x99,5x57	6	8697435181149

# SMYRNA

18161

*Clothes*

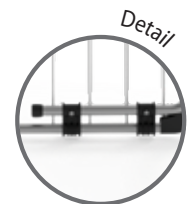
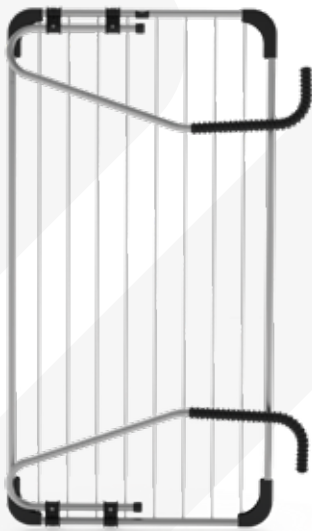

Item	Material	Weight Item / Master	Item Open Size a x b x c (cm)	Hanging Capacity (m)	Item Closed Size (cm)	m <sup>3</sup> Item / Master	Tube Size (ø)	Master Size a x b x c (cm)	Pcs. per Master	EAN
Smyrna 18161	100% Steel with Epoxy Powder Coating	1,46 / 12,8	106x55,5x26	10	55x105	0,013 / 0,110	16	18,5x56,5x105,5	8	8697435181613

# Dryer

# THINK

## 18108



Item	Material	Weight Item / Master	Item Open Size a x b x c (cm)	Hanging Capacity (m)	Item Closed Size (cm)	m <sup>3</sup> Item / Master	Tube Size (ø)	Master Size a x b x c (cm)	Pcs. per Master	EAN
Think 18108	100% Steel with Epoxy Powder Coating	1,22 / 13,08	105x55,5x28	10	55,5x105	0,015 / 0,155	14	56,5x108x25,5	10	8697435181088

# LUNA

18143

*Clothes  
Dryer*

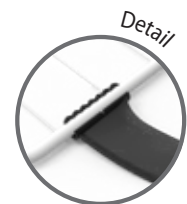

Item	Material	Weight Item / Master	Item Open Size a x b x c (cm)	Hanging Capacity (m)	Item Closed Size (cm)	m <sup>3</sup> Item / Master	Tube Size (ø)	Master Size a x b x c (cm)	Pcs. per Master	EAN
Luna 18143	100% Steel with Epoxy Powder Coating	0,32 / 6,96	51,5x35,5x14,5	2,5	35,5x51,5	0,002 / 0,052	12	35,5x53x28	20	8697435181439

Tube

Tube

# DETAILS

**A**

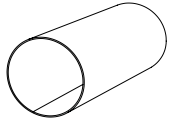

Ø 12

18143 LUNA

**B**

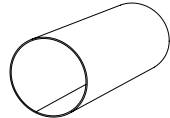

Ø 14

18108 THINK  
18114 JUNIOR  
18117 FLORA

**C**



Ø 16

18101 CAPRI  
18105 CAPRI LUX  
18111 WINGS LUX  
18111-01 HERO  
18116 HANDY  
18128 SMART  
18130 COSMOS  
18161 SMYRNA  
18137 STREAM 2  
18138 STREAM 3  
18139 STREAM 4

**D**

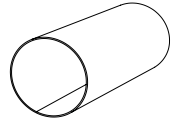

Ø 12-14-14

18121 STAR

**E**



Ø 12-14-16

18109 WINGS BODRUM  
18120 AEGEANSTAR  
18120-01 AEGEANSTAR LUX  
18124 FANTASY  
18124-01 FANTASY LUX

**F**

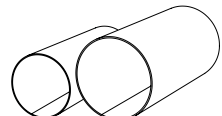

Ø 14-16

18110 UNO  
18142 ISTANBUL LUX

**G**

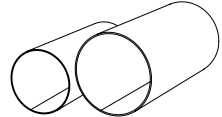

Ø 16-19

18132 FLEXY 160  
18133 FLEXY 220

# Cap

## DETAILS

**A**



18110 UNO  
18114 JUNIOR  
18120 AEGEANSTAR  
18120-01 AEGEANSTAR LUX  
18121 STAR  
18124 FANTASY  
18124-01 FANTASY LUX

**B**



18101 CAPRI  
18105 CAPRI LUX  
18108 THINK  
18109 WINGS BODRUM  
18117 FLORA  
18128 SMART  
18130 COSMOS  
18142 ISTANBUL LUX  
18161 SMYRNA  
18111 WINGS LUX  
18116 HANDY

**C**

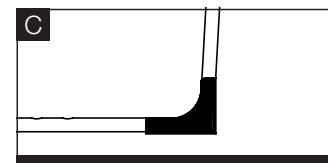

18132 FLEXY 160  
18133 FLEXY 220

**F**

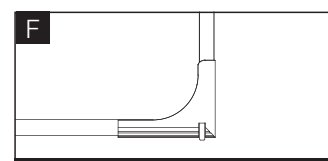

18111-01 HERO

**E**

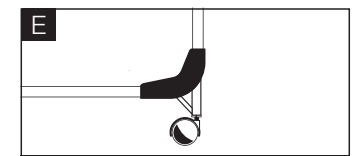

18137 STREAM 2  
18138 STREAM 3  
18139 STREAM 4

# Other

## DETAILS

Other

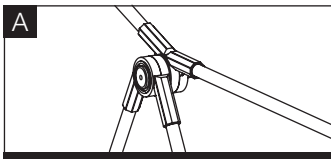

18130 COSMOS  
18128 SMART  
18117 FLORA

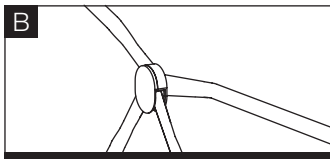

18116 HANDY  
18114 JUNIOR  
18105 CAPRI LUX  
18101 CAPRI

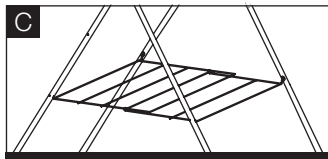

18130 COSMOS  
18128 SMART  
18117 FLORA  
18116 HANDY  
18114 JUNIOR  
18105 CAPRI LUX  
18101 CAPRI

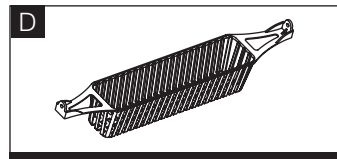

18116 HANDY  
18105 CAPRI LUX

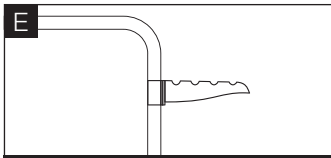

18139 STREAM 4  
18138 STREAM 3  
18137 STREAM 2

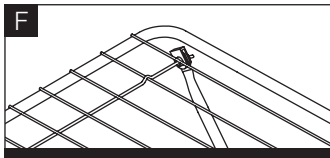

18124 FANTASY  
18120 AEGEANSTAR  
18121 STAR  
18111 WINGS LUX  
18110 UNO  
18109 WINGS BODRUM

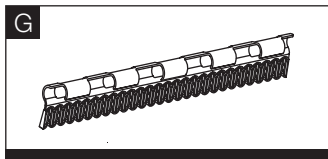

18133 FLEXY 220  
18132 FLEXY 160  
18116 HANDY  
18111 WINGS LUX

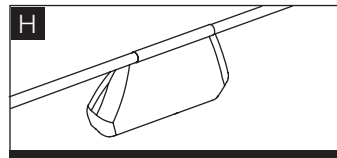

18130 COSMOS  
18128 SMART  
18117 FLORA

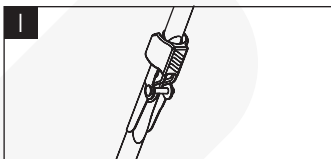

18124-01 FANTASY LUX  
18120-01 AEGEANSTAR LUX

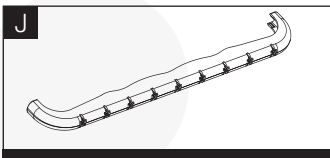

18109 WINGS BODRUM

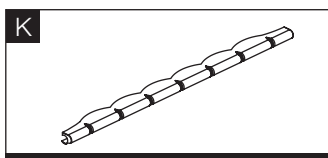

18142 ISTANBUL LUX

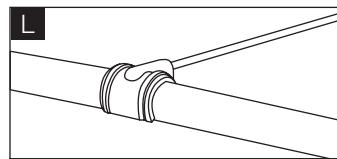

18130 COSMOS  
18128 SMART

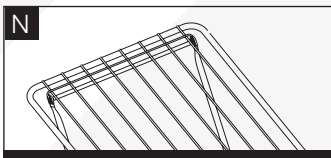

18111-01 HERO

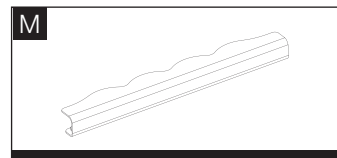

18111-01 HERO



# Meters

# Meters

## DETAILS



**2,5 M**  
18143 LUNA



**10 M**  
18110 UNO  
18161 SMYRNA  
18108 THINK



**16 M**  
18121 STAR  
18132 FLEXY 160  
18128 SMART  
18117 FLORA  
18114 JUNIOR



**18 M**  
18142 ISTANBUL LUX  
18111 WINGS LUX  
18111-01 HERO  
18109 WINGS BODRUM  
18120-01 AEGEANSTAR LUX  
18120 AEGEANSTAR



**20 M**  
18124-01 FANTASY LUX  
18124 FANTASY  
18130 COSMOS  
18116 HANDY  
18105 CAPRI LUX  
18101 CAPRI  
18137 STREAM 2



**22 M**  
18133 FLEXY 220



**30 M**  
18138 STREAM 3



**40 M**  
18139 STREAM 4

# Camping



Products



# PALIO

18610

Camping



Product Colours



Item	Material	Weight Item / Master	Outer Dimensions a x b x c (cm)	Inner Dimensions a x b x c x d (cm)	Item Closed Size (cm)	Item m <sup>3</sup> Item / Master	Tube Size (ø)	Master Size a x b x c (cm)	Pcs. per Master	EAN
Palio 18610	100% Steel with Epoxy Powder Coating 600D Polyester Fabric	1,96 / 17,64	79x45x81	40x39x40x43	13x13x80	0,009 / 0,077	16	22x83,5x42	8	8697435186106

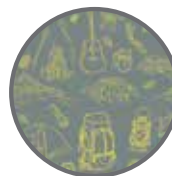

Available Product Designs

(Different designs can be produced)

Item	Material	Weight Item / Master	Outer Dimensions a x b x c (cm)	Inner Dimensions a x b x c x d (cm)	Item Closed Size (cm)	Item / Master m <sup>3</sup>	Tube Size (ø)	Master Size a x b x c (cm)	Pcs. per Master	EAN
Nario 18632	100% Steel with Epoxy Powder Coating 600D Polyester Fabric	1,96 / 17,64	79x45x81	40x39x40x43	13x13x80	0,009 / 0,077	16	22x83,5x42	8	8697435186328

# DANTE

18618

Camping



Item	Material	Weight Item / Master	Outer Dimensions a x b x c (cm)	Inner Dimensions a x b x c x d (cm)	Item Closed Size (cm)	Item m <sup>3</sup> Item / Master	Tube Size (ø)	Master Size a x b x c (cm)	Pcs. per Master	EAN
Dante 18618	100% Steel with Epoxy Powder Coating 600D Polyester Fabric	1,94 / 13,46	78x45x74	40x46x37x41	13x13x80	0,01 / 0,061	16	24x79,5x32	6	8697435186144



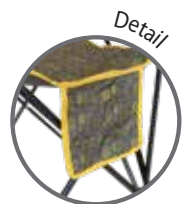

Item	Material	Weight Item / Master	Outer Dimensions a x b x c (cm)	Inner Dimensions a x b x c x d (cm)	Item Closed Size (cm)	Item m <sup>3</sup> Item / Master	Tube Size (ø)	Master Size a x b x c (cm)	Pcs. per Master	EAN EAN
Lucco 18636	100% Steel with Epoxy Powder Coating 600D Polyester Fabric	1,94 / 13,46	78x45x74	40x46x37x41	13x13x80	0,01 / 0,061	16	24x79,5x32	6	8697435186366



# PAPSY

18626

Camping



(Different designs can be produced)

Item	Material	Weight Item / Master	Outer Dimensions a x b x c (cm)	Inner Dimensions a x b x c x d (cm)	Item Closed Size (cm)	m <sup>3</sup> Item / Master	Tube Size (ø)	Master Size a x b x c (cm)	Pcs. per Master	EAN
Papsy 18626	100% Steel with Epoxy Powder Coating 600D Polyester Fabric	1,06 / 4,9	62x28x52	35x27x23x30	10x10x57	0,005 / 0,023	14	19,5x61x20	4	8697435186267



Product Colours



Item	Material	Weight Item / Master	Outer Dimensions a x b x c (cm)	Inner Dimensions a x b x c x d (cm)	Item Closed Size (cm)	Item m <sup>3</sup> Item / Master	Tube Size (ø)	Master Size a x b x c (cm)	Pcs. per Master	EAN EAN
Tito 18638	100% Steel with Epoxy Powder Coating 600D Polyester Fabric	3,3 / 14,1	101x50x96	59x44x46x45	14x21x93	0,017 / 0,069	16	28x95x26	4	8697435186380

# COMFY

18674

Camping



Item	Material	Weight Item / Master	Outer Dimensions a x b x c (cm)	Inner Dimensions a x b x c x d (cm)	Item Closed Size (cm)	Item / Master m <sup>3</sup>	Tube Size (ø)	Master Size a x b x c (cm)	Pcs. per Master	EAN
Comfy 18674	100% Steel with Epoxy Powder Coating 600D Polyester Fabric	5,25 / 22,05	96x61x59	59x53x40x44	17x21x98	0,026 / 0,106	16	34x110x28,5	4	8697435186724



Product Colours



Item	Material	Weight Item / Master	Outer Dimensions a x b x c (cm)	Inner Dimensions a x b x c x d (cm)	Item Closed Size (cm)	Item / Master m <sup>3</sup>	Tube Size (ø)	Master Size a x b x c (cm)	Pcs. per Master	EAN EAN
Picco 18645	100% Steel with Epoxy Powder Coating 600D Polyester Fabric	2,6 / 16,8	80x46x51,5	48,5x36x40x43	57,5x72	0,027 / 0,162	19	38,5x58,5x72	6	8697435186588



# RETRO

18658

Camping



### Product Colours



Item	Material	Weight Item / Master	Outer Dimensions a x b x c (cm)	Inner Dimensions a x b x c x d (cm)	Item Closed Size (cm)	Item m <sup>3</sup> / Master	Tube Size (ø)	Master Size a x b x c (cm)	Pcs. per Master	EAN
Retro 18658	100% Steel with Epoxy Powder Coating 600D Polyester Fabric	2,6 / 16,8	80x46x51,5	48,5x36x40x43	57,5x72	0,027 / 0,162	19	38,5x58,5x72	6	8697435186427



Product Colours



Item	Material	Weight Item / Master	Outer Dimensions a x b x c (cm)	Inner Dimensions a x b x c x d (cm)	Item Closed Size (cm)	Item / Master m <sup>3</sup>	Tube Size (ø)	Master Size a x b x c (cm)	Pcs. per Master	EAN
Item <b>Pixy</b> 18672	100% Steel with Epoxy Powder Coating 600D Polyester Fabric	2,85 / 12,6	82x53,5x51,5	52x38x43x38	56x75	0,036 / 0,144	19	33,5x57x75,5	4	8697435186724



# PRETTY

18670

Camping



Available Product Designs

(Different designs can be produced)

Item	Material	Weight Item / Master	Outer Dimensions a x b x c (cm)	Inner Dimensions a x b x c x d (cm)	Item Closed Size (cm)	Item m <sup>3</sup> / Master	Tube Size (ø)	Master Size a x b x c (cm)	Pcs. per Master	EAN
Item <b>Pretty</b> 18672	100% Steel with Epoxy Powder Coating 600D Polyester Fabric	2,6 / 16,8	80x46x51,5	48,5x36x40x43	57,5x72	0,,027 / 0,162	16	38,5x58,5x72	6	8697435186700





Product Colours



Item	Material	Weight Item / Master	Outer Dimensions a x b x c (cm)	Inner Dimensions a x b	Item Closed Size (cm)	m <sup>3</sup> Item / Master	Tube Size (ø)	Master Size a x b x c (cm)	Pcs. per Master	EAN EAN
Tino 18664	100% Steel with Epoxy Powder Coating 600D Polyester Fabric	0,065 / 5,65	36x27x36,5	26x25	37x44	0,0039 / 0,03	19	41x48,5x15,7	8	8697435186663

# GIAN

18660

Camping

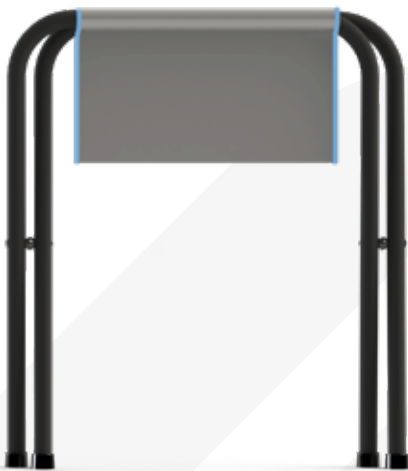

### Product Colours



Item	Material	Weight Item / Master	Outer Dimensions a x b x c (cm)	Inner Dimensions a x b	Item Closed Size (cm)	m <sup>3</sup> Item / Master	Tube Size (ø)	Master Size a x b x c (cm)	Pcs. per Master	EAN
Gian 18660	100% Steel with Epoxy Powder Coating 600D Polyester Fabric	1,05 / 9,1	40x32x40	31x30	50x42	0,0068 / 0,054	19	42x52x25	8	8697435186601

*F Products*

# FISHER

18668



Product Colours



Item	Material	Weight Item / Master	Outer Dimensions a x b x c (cm)	Inner Dimensions a x b	Item Closed Size (cm)	m <sup>3</sup> Item / Master	Tube Size (ø)	Master Size a x b x c (cm)	Pcs. per Master	EAN EAN
Fisher 18668	100% Steel with Epoxy Powder Coating 600D Polyester Fabric	1,2 / 12,68	38x32x68	25x28x38x15	50x38	0,006 / 0,063	19	44x52x29	10	8697435186687

# MATTY

18690

Camping



Product Colours



Item	Material	Weight Item / Master	Outer Dimensions a x b x c (cm)	Inner Dimensions a x b	Item Closed Size (cm)	m <sup>3</sup> Item / Master	Tube Size (ø)	Master Size a x b x c (cm)	Pcs. per Master	EAN
Matty 18690	100% Steel with Epoxy Powder Coating 600D Polyester Fabric	5,2 / 11,1	190x72x42	183x52	13x19x93	0,018 / 0,037	25x35	94x22x18	2	8697435186908



Product Colours



Item	Material	Weight Item / Master	Dimensions a x b x c (cm)	Item Closed Size (ø)	Item / Master m <sup>3</sup>	Fiberglass Tube (ø)	Master Size a x b x c (cm)	Pcs. per Master	EAN
Poppy 18695	100% Steel with Epoxy Powder Coating 190T Polyester Fabric	1,3 / 6,05	225x126x92,5	68x10	0,015 / 0,060	5,5	68x68x13	4	8697435186953

# SUNSHINE

18680

Camping  
Products



Item	Material	Weight Item / Master	Outer Dimensions a x b x c (cm)	Person	Item Closed Size (cm)	DNS	Tube Size (a)	m <sup>3</sup> Master	Master Size a x b x c (cm)	Pcs. per Master	EAN
Sunshine 18680	100% Steel with Epoxy Powder Coating 600D Polyester Fabric	19 / 20,8	175x110x151	3	43x130	14	20x30-38-25-16-13	0,16	18,5x174x53	1	8697435186809

# Tube DETAILS

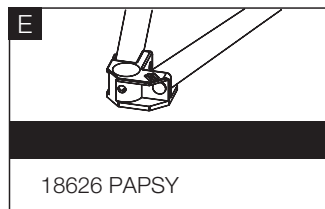
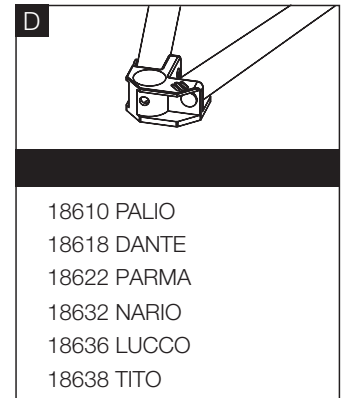
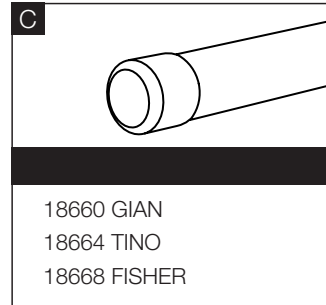
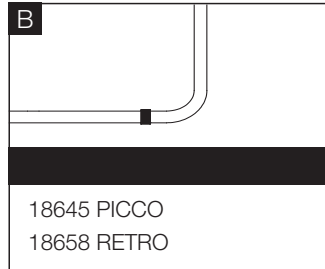
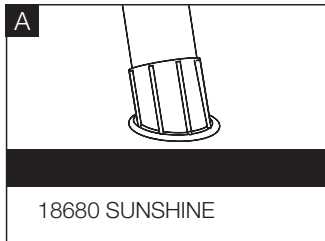

# Cap DETAILS

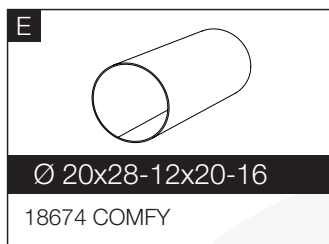
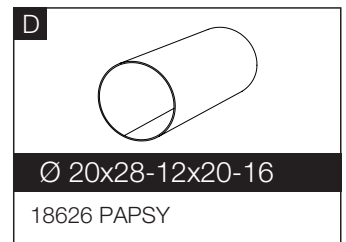
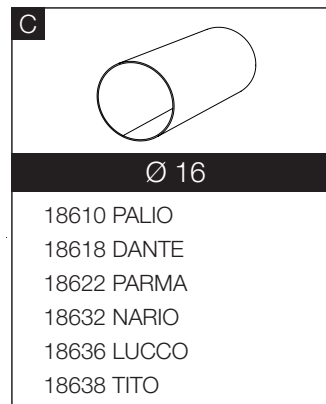
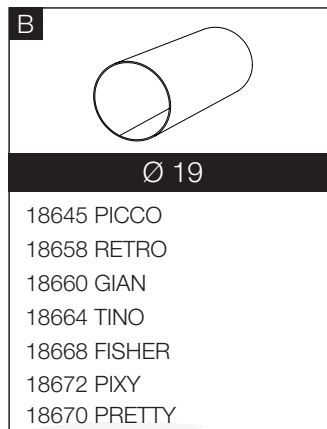
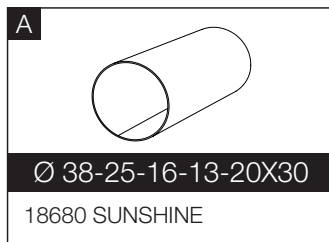

# Other DETAILS

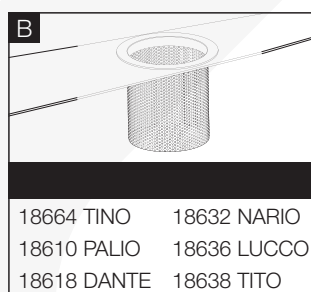
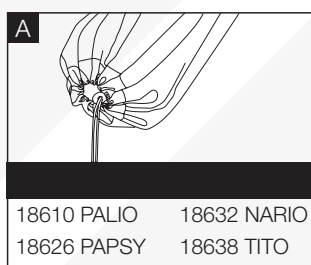



# Tiny

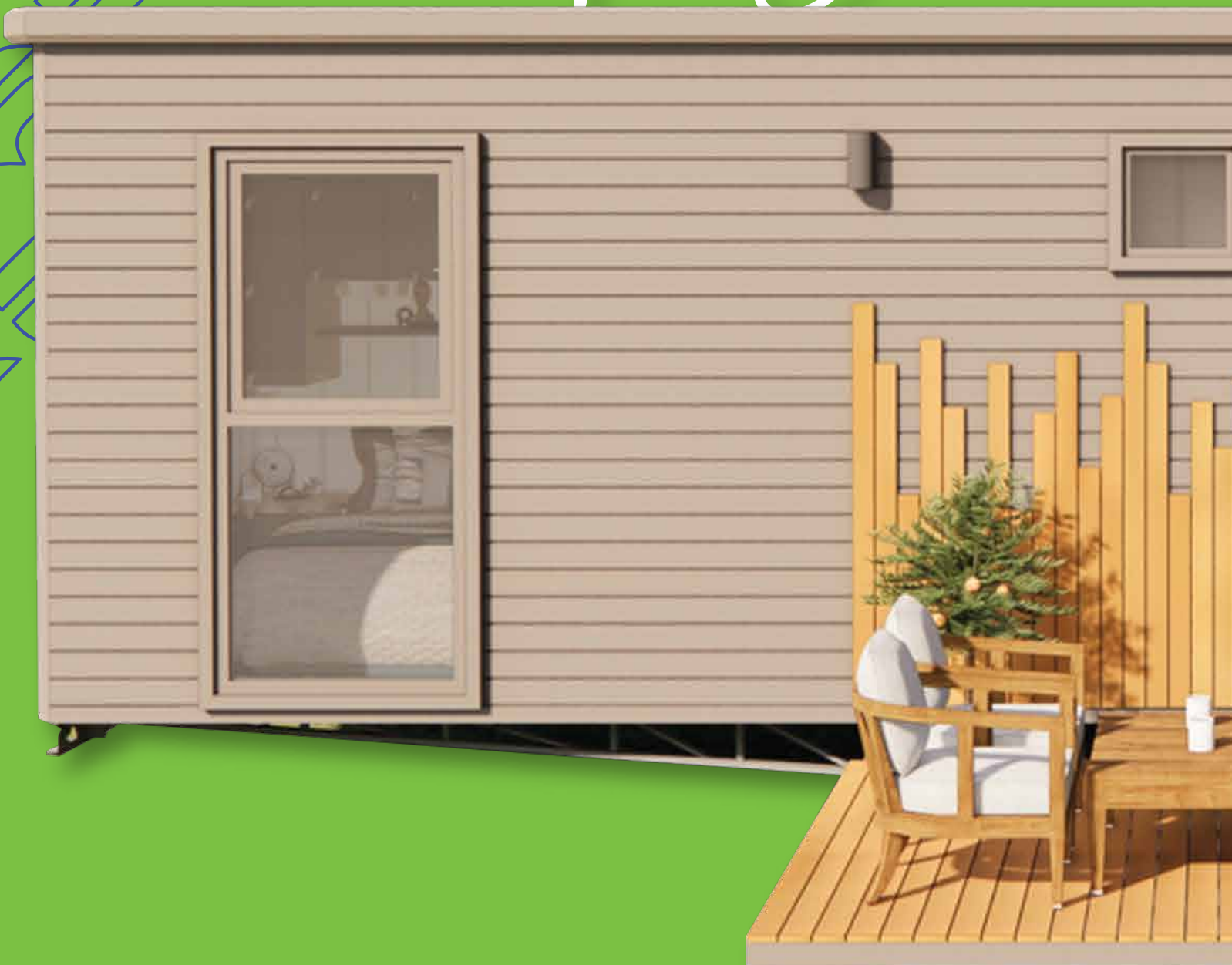

# Houses



# 6500 FLAT (2+0)

*Tiny*





# Technical Properties

## Outside dimensions:

6.500mm x 2.55m - h: 2.500mm

## Internal dimensions:

6.368mm x 2.35m - h: 2.448mm

**Living Area:** 14m<sup>2</sup>

**Accommodation Capacity:** 2 Adults

**Axle Carrying Capacity:** 3,500kg

**License Features:** With O2 Certificate and License Plate

## Carrier System Modular:

### Industrial Painted, Reinforced Chassis

The chassis consists of a box profile carcass and is welded by gas welding. After the chassis strengthening process, the chassis of the vehicle becomes a more rigid body.

## Structure and Roof System:

### Roof; FRP Composite Panel Technology

Glass fiber reinforced (GRP) is a composite material containing glass fibers reinforced with a thermoset or thermoplastic matrix material.

FRP combines high strength, lightness, high hardness, high fatigue resistance and chemical resistance.

## Exterior Facade;

### Composite Sandwich Panel

It is a polyurethane insulated panel, covered with 60 mm sheet metal on both sides. The biggest advantage of Polyurethane/Insulated Facade Panels is the high thermal insulation it provides with low insulation thickness.

## Exterior Facade:

### JOTUN Grainy Ready Decorative Coating

Thanks to its fine grain structure, it gives buildings a decorative and protective appearance.

It provides long-term use thanks to its plastered metal surfaces and self-supporting acrylic emulsion-based, high-quality materials.

## Interior Facade:

### Wall Panel

Beyond being just a static element surrounding a room, AGT wall profile offers both a functional and aesthetic solution thanks to its ability to absorb sound with its acoustic wall profile, allowing you to create quieter and more peaceful spaces.

## Floor Coating:

### Class 32 Laminate Flooring

It is anti-allergenic and made of 90% wood-based composites (the main layer is usually HDF). Anti Bacterial Comfort is an anti-bacterial coating to prevent bacterial growth and provides a clean environment.

## Joinery System:

### PVC Facade System / Insulating Glass Synergy

**Bathroom Furniture:** Water and moisture resistant MDF laminated flooring is used in kitchen and bathroom furniture. First class sanitaryware products are used in kitchens and bathrooms.

## Heating & Cooling System:

1 Unit 12.000 BTU Air Conditioner Infrastructure – Ready to be Installed

1 Instant Water Heater Infrastructure – Ready to be Installed

**Ventilation:** 1 Piece Vent System

## Electricity System:

### NYM Cable

24 fuse box consisting of 20 Amperes and 32 Amperes will be used along with the residual current relay.

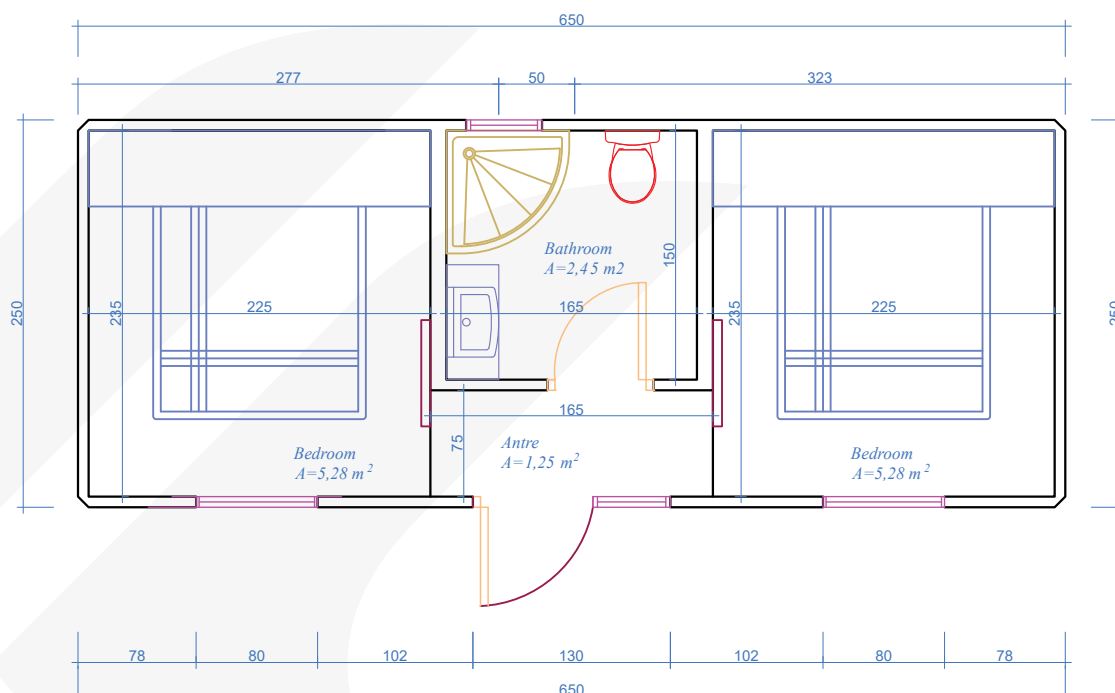

# 6500 FLAT (1+1)

*Tiny*



# Technical Properties

## Outside dimensions:

6.500mm x 2.55m - h: 2.500mm

## Internal dimensions:

6.368mm x 2.35m - h: 2.448mm

**Living Area:** 14m<sup>2</sup>

**Accommodation Capacity:** 2 Adults

**Axle Carrying Capacity:** 3,500kg

**License Features:** With O2 Certificate and License Plate

## Carrier System Modular:

### Industrial Painted, Reinforced Chassis

The chassis consists of a box profile carcass and is welded by gas welding. After the chassis strengthening process, the chassis of the vehicle becomes a more rigid body.

## Structure and Roof System:

### Roof; FRP Composite Panel Technology

Glass fiber reinforced (GRP) is a composite material containing glass fibers reinforced with a thermoset or thermoplastic matrix material.

FRP combines high strength, lightness, high hardness, high fatigue resistance and chemical resistance.

## Exterior Facade;

### Composite Sandwich Panel

It is a polyurethane insulated panel, covered with 60 mm sheet metal on both sides. The biggest advantage of Polyurethane/Insulated Facade Panels is the high thermal insulation it provides with low insulation thickness.

## Exterior Facade:

### JOTUN Grainy Ready Decorative Coating

Thanks to its fine grain structure, it gives buildings a decorative and protective appearance.

It provides long-term use thanks to its plastered metal surfaces and self-supporting acrylic emulsion-based, high-quality materials.

## Interior Facade:

### Wall Panel

Beyond being just a static element surrounding a room, AGT wall profile offers both a functional and aesthetic solution thanks to its ability to absorb sound with its acoustic wall profile, allowing you to create quieter and more peaceful spaces.

## Floor Coating:

### Class 32 Laminate Flooring

It is anti-allergenic and made of 90% wood-based composites (the main layer is usually HDF). Anti Bacterial Comfort is an anti-bacterial coating to prevent bacterial growth and provides a clean environment.

## Joinery System:

### PVC Facade System / Insulating Glass Synergy

**Kitchen & Bathroom Furniture:** Water and moisture resistant MDF laminated flooring is used in kitchen and bathroom furniture. First class sanitaryware products are used in kitchens and bathrooms.

## Heating & Cooling System:

1 Unit 12.000 BTU Air Conditioner Infrastructure – Ready to be Installed

1 Instant Water Heater Infrastructure – Ready to be Installed

**Ventilation:** 1 Piece Vent System

## Electricity System:

### NYM Cable

24 fuse box consisting of 20 Amperes and 32 Amperes will be used along with the residual current relay.

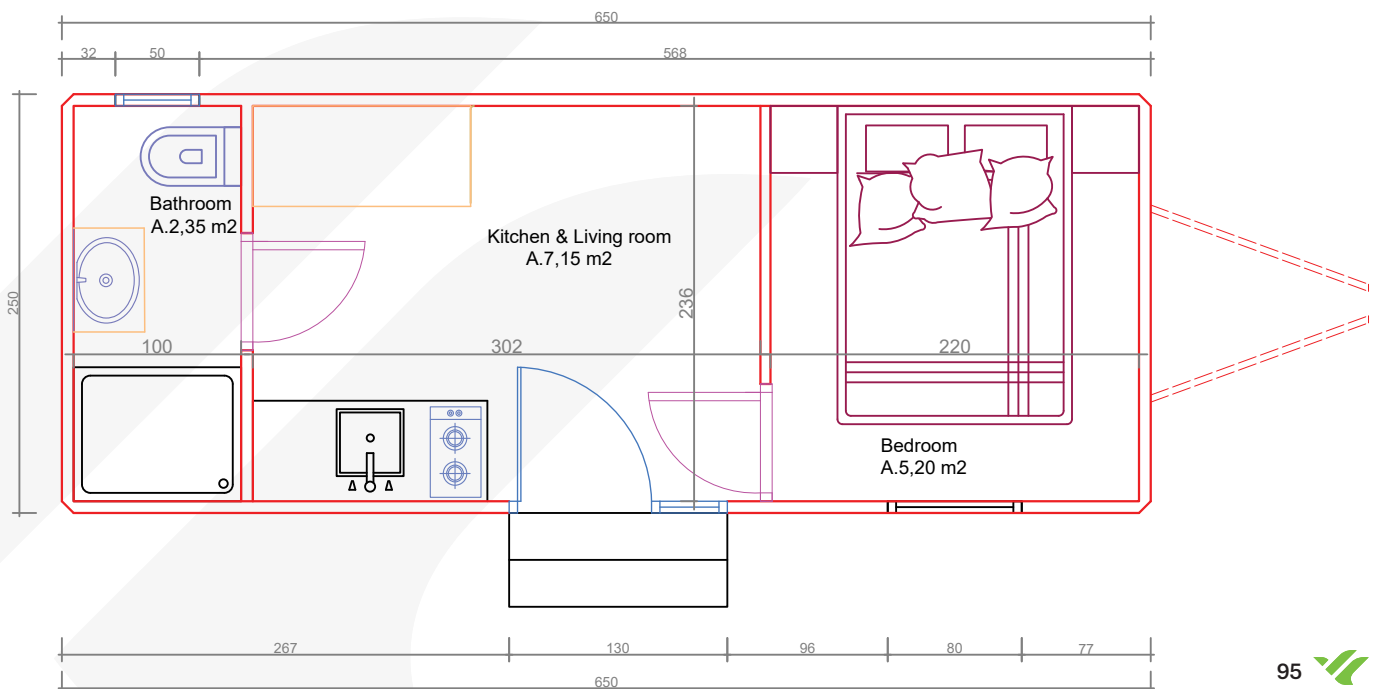



# 8500 FLAT (2+1)

*Tiny*





# Technical Properties

## Outside dimensions:

8.500mm x 2.50m - h: 2.500mm

## Internal dimensions:

8.368mm x 2.35m - h: 2.448mm

**Living Area:** 20m<sup>2</sup>

**Accommodation Capacity:** 4 Adults

**Axle Carrying Capacity:** 3,500kg

**License Features:** With O2 Certificate and License Plate

## Carrier System Modular:

### Industrial Painted, Reinforced Chassis

The chassis consists of a box profile carcass and is welded by gas welding. After the chassis strengthening process, the chassis of the vehicle becomes a more rigid body.

## Structure and Roof System:

### Roof; FRP Composite Panel Technology

Glass fiber reinforced (GRP) is a composite material containing glass fibers reinforced with a thermoset or thermoplastic matrix material.

FRP combines high strength, lightness, high hardness, high fatigue resistance and chemical resistance.

## Exterior Facade:

### Composite Sandwich Panel

It is a polyurethane insulated panel, covered with 60 mm sheet metal on both sides. The biggest advantage of Polyurethane/Insulated Facade Panels is the high thermal insulation it provides with low insulation thickness.

## Exterior Facade:

### JOTUN Grainy Ready Decorative Coating

Thanks to its fine grain structure, it gives buildings a decorative and protective appearance.

It provides long-term use thanks to its plastered metal surfaces and self-supporting acrylic emulsion-based, high-quality materials.

## Interior Facade:

### Wall Panel

Beyond being just a static element surrounding a room, AGT wall profile offers both a functional and aesthetic solution thanks to its ability to absorb sound with its acoustic wall profile, allowing you to create quieter and more peaceful spaces.

## Floor Coating:

### Class 32 Laminate Flooring

It is anti-allergenic and made of 90% wood-based composites (the main layer is usually HDF). Anti Bacterial Comfort is an anti-bacterial coating to prevent bacterial growth and provides a clean environment.

## Joinery System:

### PVC Facade System / Insulating Glass Synergy

**Kitchen & Bathroom Furniture:** Water and moisture resistant MDF laminated flooring is used in kitchen and bathroom furniture. First class sanitaryware products are used in kitchens and bathrooms.

## Heating & Cooling System:

1 Unit 12.000 BTU Air Conditioner Infrastructure – Ready to be Installed

1 Instant Water Heater Infrastructure – Ready to be Installed

**Ventilation:** 1 Piece Vent System

## Electricity System:

### NYM Cable

24 fuse box consisting of 20 Amperes and 32 Amperes will be used along with the residual current relay.

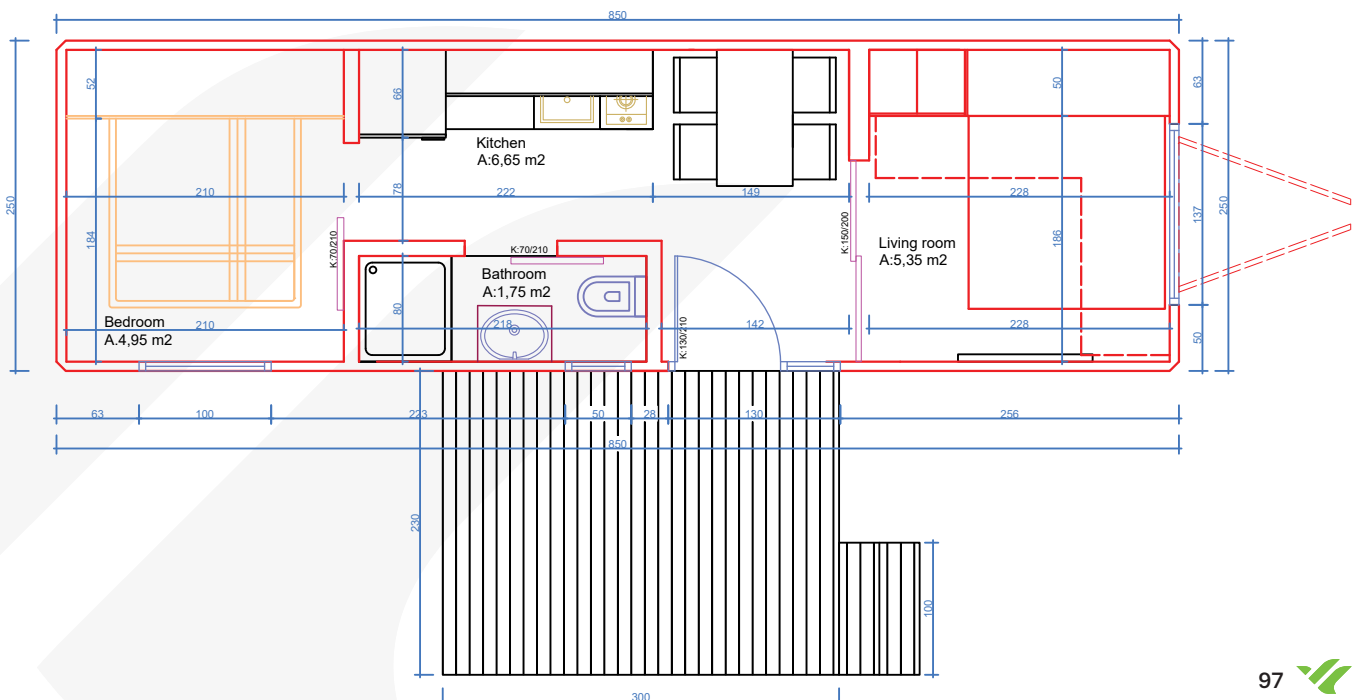





### FACTORY I

A: 7 Eylül Mah. Umit Tuncag Cad. No:3 Torbali - IZMIR / TÜRKİYE  
T: +90 232 853 73 80 (pbx) F: +90 232 853 70 05  
export@egehomeproducts.com

### FACTORY II

A: 29 Ekim Mah. Batibeton Cad. No:7 Yazibasi - Torbali - IZMIR / TÜRKİYE  
T: +90 232 853 73 80 (pbx) F: +90 232 853 70 05  
export@egehomeproducts.com

### FACTORY III

A: 14 Via Rotterdam, Ferr, FE 44122, 44122 Ferrara FE, ITALY  
T: +39 0532 771502  
export@egehomeproducts.com

### LOGISTICS CENTER

A: 29 Ekim Mah. Karabag Sok. No:19 Yazibasi - Torbali - IZMIR / TÜRKİYE  
T: +90 232 853 73 80 (pbx) F: +90 232 853 70 05  
export@egehomeproducts.com

### ISTANBUL BRANCH

A: Istoc C Plaza 2412 Sk. No:2 C Plaza K:4 D:32  
Mahmutbey - Bagcilar - ISTANBUL / TÜRKİYE  
T: +90 212 659 96 55 (pbx)  
info@egeevurunleri.com.tr



Management  
System  
ISO 9001:2015  
ISO 14001:2015  
www.tuv.com  
ID: 9105042395



amfori @ BSCI  
Trade with purpose



ISO 9001:2015  
01 100 901545



MAISONS INDIVIDUELLES